

Getting the Most
out of the
FERGUSON SYSTEM



A HANDBOOK ON OPERATION AND CARE

The Sign . . .



of a

New Prosperity

in Agriculture

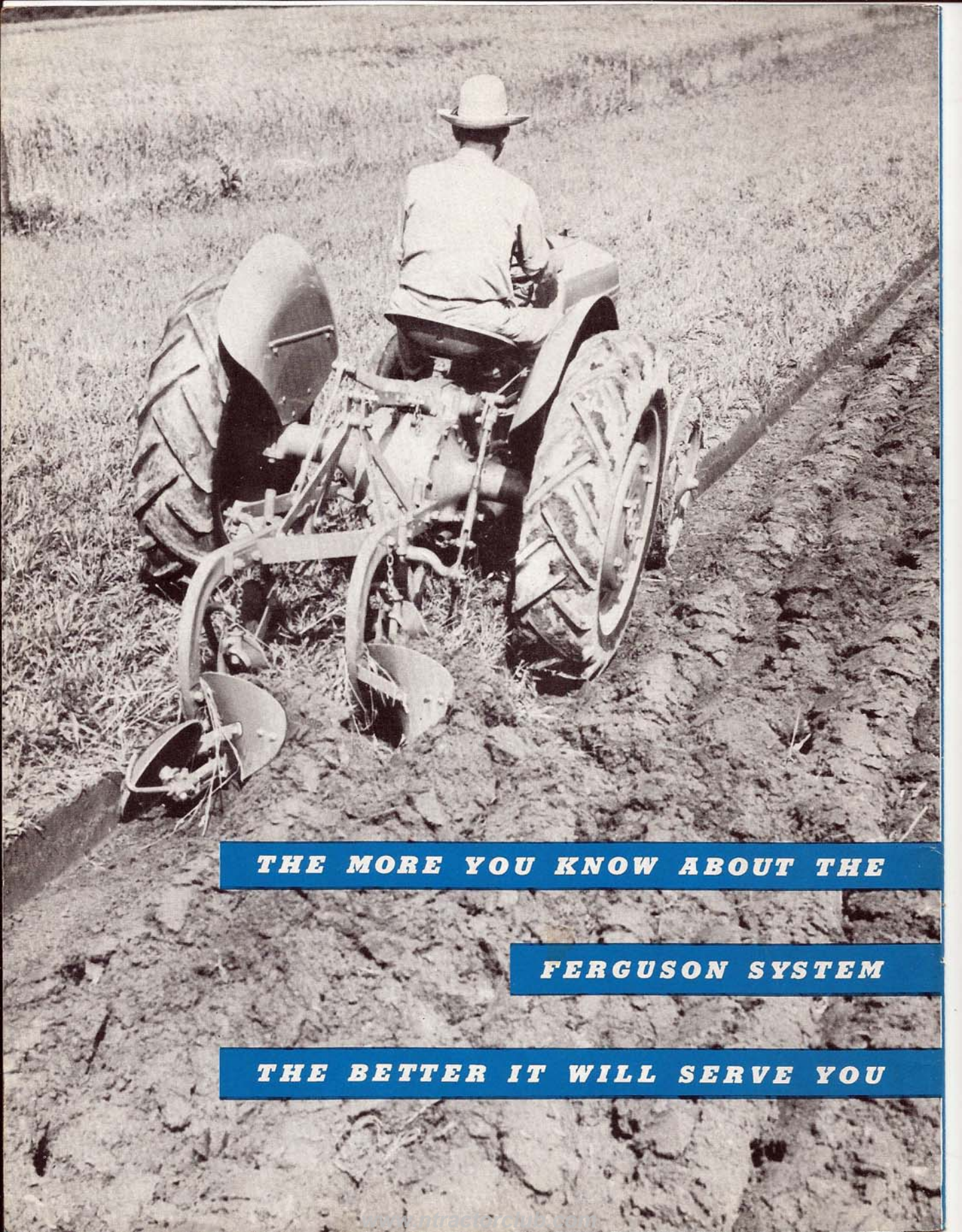

THE MORE YOU KNOW ABOUT THE

FERGUSON SYSTEM

THE BETTER IT WILL SERVE YOU



The individual farmer has little, if any, control over market prices, but he does have a way of increasing his profits—by cutting production costs.

Harry Ferguson has made it possible to reduce farming costs by inventing a new method of implement attachment and control, and by developing a line of implements which reduce farm labor to a minimum. This new method is called the Ferguson System.

As an owner, you already know a good deal about the Ferguson System. This book, we hope, will give you a still better understanding of it. The more you know about the Ferguson System, the better it will serve you. And this means that you will get more enjoyment, and make more money, by farming with it.



CONTENTS

	Page
TAKING SIDES WITH NATURE	
Explaining the Ferguson System.....	5-10
 POINTERS ON OPERATION	
Tractor	10-20
Plow	20-29
Disc Harrow.....	29-34
Cultivator	34-37
Tiller	37-39
 CARE OF THE TRACTOR	 40-56
 PULLEY AND BELT SPEEDS.....	 57
 TRACTOR MAINTENANCE SCHEDULE.....	 58
 TRACTOR LUBRICATION CHART.....	 59
 LUBRICATION CHARTS	
Disc Terracer.....	60
2-Bottom Moldboard Plows.....	61
Disc Plow.....	62
Tandem Disc Harrow.....	63
Single Disc Harrow.....	64
Heavy-Duty Disc Harrow.....	65
Agricultural Mower.....	66
Heavy-Duty Mower	67
Lister Planter Attachment.....	68
Lister Cultivator.....	69
Corn Picker.....	70-71
 INDEX	 72
 RECORD OF TRACTOR WORKING HOURS.....	 Center Pages

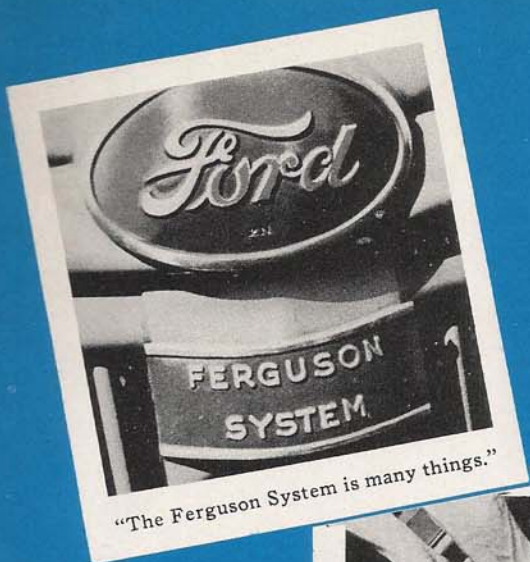

"The Ferguson System is many things."

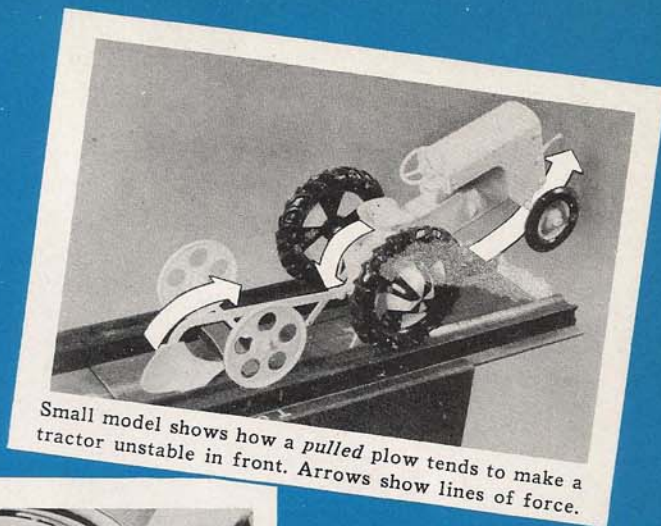

Small model shows how a pulled plow tends to make a tractor unstable in front. Arrows show lines of force.

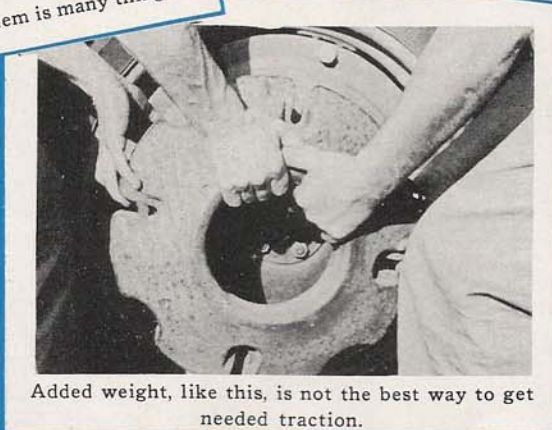

Added weight, like this, is not the best way to get needed traction.

TAKING SIDES WITH NATURE

First, let us describe the chief advantages of the Ferguson System. By seeing what it is and what it does, we can better understand how to get the most out of it.

What is the Ferguson System? Well, it is many things; the things that, taken together, make the Ford Tractor Ferguson System and Ferguson Implements so entirely different. The Ferguson System is a combination of engineering advancements that work together to make modern, easier farming possible.

Instead of trying to work

against certain laws of Nature, the Ferguson System puts these very same forces to work. It takes sides with Nature.

There is a law of Nature that conventional tractors work against. You can state it this way: Because of the resistance of the implement as it is being pulled through the ground, and because of its method of attachment to the tractor, a pulled plow tends to kick up behind and, in effect, *pushes down* on the tractor drawbar. This downward force on the drawbar tends to raise the tractor up in front. In

other words, the whole outfit tends to revolve upward around the rear wheels as a pivot. The plow tends to revolve upward behind, and the tractor tends to revolve upward in front. The heavier the load, the more there is of this tendency to "jack-knife".

The only answer seemed to be weight, and more weight. And so, to this very day, tractors have been built long and heavy, and implements have been made heavy, in order to keep the whole thing from rearing up and folding over.



Natural tendency of the plow (without top link) is to revolve when pulled forward.

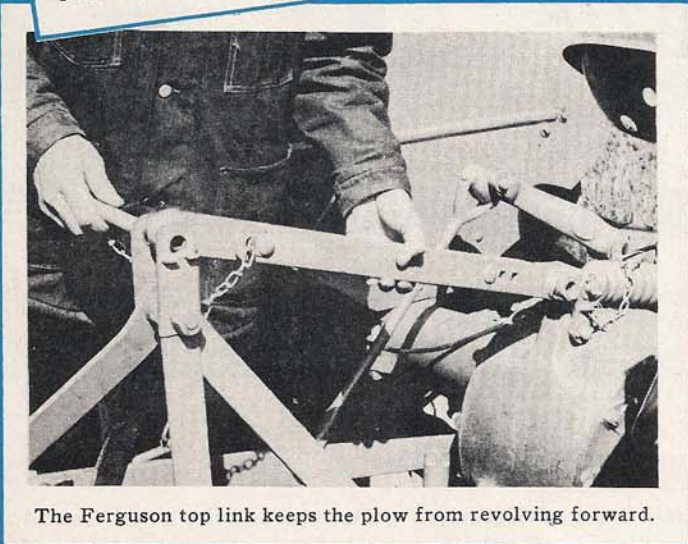

The Ferguson top link keeps the plow from revolving forward.

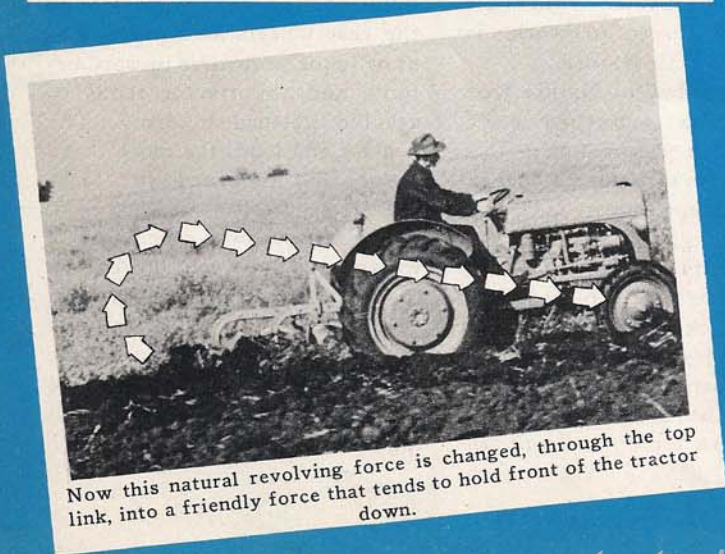

Now this natural revolving force is changed, through the top link, into a friendly force that tends to hold front of the tractor down.

But the farmer had to pay for all this heavy cast iron. He had to pay for hauling it over his fields, in gas and oil. He had to pay for heavy replacement parts and expensive repairs. He had to pay, too, with hard physical toil, to operate machinery with so much excess weight. Then suddenly, one man changed all this, almost overnight.

How Strong, Yet Light, Steel Arms Replaced Heavy Built-in Weight

Harry Ferguson saw something that no one else had seen before. He said, "Instead of weighting the front end down, why not *brace* it down?"

Brace it against what? Why, of course—against the implement that is always trying to kick up behind while being pulled through the ground. Yes, that's it—a brace, well above the tractor rear axle, connecting the implement and the tractor.

There you have the exclusive *top link* of the Ferguson System. With it, we work with, instead of against, the forces of Nature. By attaching the cross-shaft of the implement to the two bottom links (instead of pulling the implement on wheels) the forward revolving action of the implement is changed, through the top link, into a strong forward and downward pushing force, right down to the front of the tractor.

This tends to hold the front end down.

The Advantages of Hydraulic Power

In order to gain the greatest benefit from the Ferguson linkage, it is raised and lowered by a powerful hydraulic pump driven by the power take-off shaft. The action of the pump in moving the linkage is controlled: (1) manually, by the finger tip control lever, and (2) automati-

cally, through the control spring (just forward of the top link connection).

This hydraulic pump on the Ford Tractor Ferguson System works much as does the hydraulic jack that lifts your car for a grease job in a filling station. Tremendous power can be generated in this way, and yet it is always under instant, "smooth-as-silk" control.

Using this hydraulic power, a mere touch of the finger tip control lever will raise the implement to carrying position, or lower it to the ground for working, or adjust its working depth as you please.

Five Things the Ferguson System Does

(1) Provides Penetration Without Weight.

The implement is attached to the tractor by two bottom links and one top link. When the implement (such as a plow) starts to enter the ground, the bottom links go into tension (start pulling) and the top link goes into compression (starts pushing). This keeps plow from rotating.

Therefore, the forward motion of the tractor actually pulls the plow into the ground without the use of excess weight.

(2) Provides Finger Tip Hydraulic Depth Control.

When the plow is in transport position, the ram cylinder is full of oil. When the finger tip control lever is moved downward, oil is released from the cylinder, allowing the plow to lower by its own weight.

Just as soon as the plow reaches the desired depth (determined by the set of the control lever), the release of oil from the ram cylinder is automatically stopped. As long as the texture of soil does not change, the implement will remain at the depth set.



Enlarged view of ram cylinder of the Ferguson Hydraulic System.

1. Provides penetration without weight.



About to lower plow. Ferguson System provides penetration without excess weight.



Through the Ferguson Hydraulic System, the implement is controlled: (1) automatically by the control spring and (2) manually, by finger tip control

2. Provides fingertip hydraulic depth control.



Desired working depth of plow is set by finger tip control lever.

4. Keeps the front end down.



The tractor's front end is held down, even when plowing uphill.

3. Traction without built-in weight.



When working, the weight of the implement, plus weight of the soil on it, plus the suck of the implement, automatically provide the traction to do the job.

On uneven ground, the expansion and contraction of the control spring regulates the flow of oil into and out of the ram cylinder, tending to keep the plow working at uniform depth.

(3) Provides Traction Without Built-in Weight.

When using a unit implement, its weight is carried on the tractor even when working through the ground. Take, for example, a plow. The weight of the plow on the tractor, and the weight of the soil on the moldboards, plus the downward suck of the plow and the resistance developed by the cutting action of the share, add extra weight on the tractor.

All of this gives added trac-

tion and eliminates the need for excess built-in weight.

Whenever the texture of the soil changes, the weight of the soil and the resistance of the plow also change.

When plowing in heavy soils, more traction is needed. This is automatically provided by the additional resistance and by the additional weight of the soil on the moldboards.

On the other hand, in loose, light soil, less traction is needed. This change is also automatically made as the resistance and the weight of soil on the moldboards decrease. In other words, the weight is changed automatically to suit the job.

(4) Keeps the Front End Down.

The bottom links are located below the rear axle of the tractor, which is the pivotal center, and the top link is located above the rear axle. When the plow enters the ground, the bottom links go into tension (pull) and the top link goes into compression (pushes). This forward push on the top link tends to keep the front end of the tractor on the ground.

(5) Automatically Protects Tractor and Implement When Obstructions Are Hit.

The instant a solid, hidden obstruction is hit, the oil pressure in the ram cylinder is automatic-

ally released. This takes the weight of the implement off the tractor.

The impact, through the linkage, transfers some of the weight from the rear to the front wheels of the tractor.

This transfer of weight, plus the loss of the weight of the implement, reduces the traction of the rear wheels. This automatic action reduces the pull on the implement and, at the same time, keeps the front end of the tractor firmly on the ground. Thus the loss of traction at the time of impact protects both tractor and implement.

Many Other Advantages, Too

We have briefly covered five important advantages of the Ferguson System. However, as was pointed out in the beginning, the Ferguson System includes many things. Here are some of its many other "extras":

1. Quick, easy change of tread widths to suit many row-crop conditions.
2. Easy backing of implements for working out corners, working in small fields, gardens and truck patches, or odd-shape lands.
3. Safety starter that will not operate if the tractor is in gear.
4. Simplified engineering that makes most field adjustments possible with only one wrench.
5. One minute attaching or detaching of implements (including cultivators).
6. Light, easily handled implements that can be backed readily into the machine shed and stored in small space.
7. Great durability combined with light weight throughout, obtained by using new, special heat-treated alloy steels.

Now, on the following pages, let us see how to operate and care for the Ferguson System in order to get the most out of it.



Striking a hidden obstacle automatically releases the pressure of oil in ram cylinder, releasing weight of implement from tractor, without detaching it.

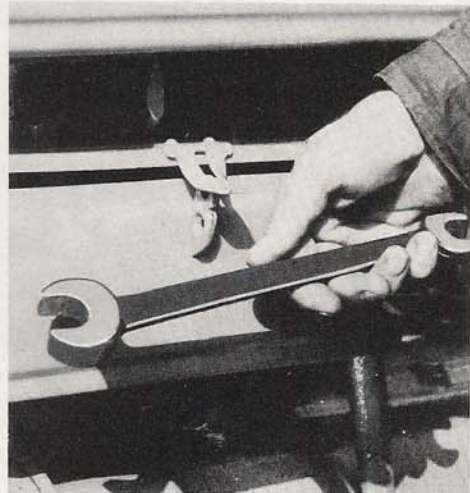

One wrench makes all usual field adjustments.



With Ferguson unit implements, backing into corners is easy.

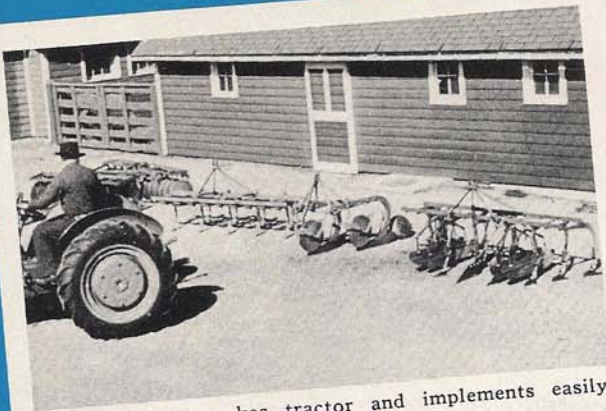

Modern design makes tractor and implements easily handled.

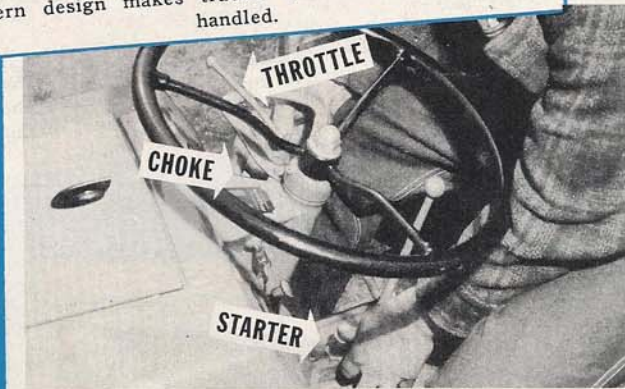

Start engine with throttle in fourth or fifth notch. Hold choke out. Press starter button.



- a. Safety starter prevents accidents . . . the starter will not work with tractor in gear.
- b. Ignition key and lock protect against unauthorized use.

"Flexible Farming"

OPERATING THE FORD TRACTOR FERGUSON SYSTEM AND FERGUSON IMPLEMENTS

The Ford Tractor Ferguson System and Ferguson Implements are easy to handle. Nevertheless, it is desirable to form habits of correct operation as, by so doing, (1) time and labor are saved (2) repairs are held to a minimum (3) the life of the equipment is prolonged (4) safe operation is assured and (5) better quality of work results.

Therefore, in this section of the book, we will take up the points of care of the most commonly used implements and, first of all, of the tractor.

Operation of the Tractor

Starting

The starter button is located on top of the transmission housing, near the gearshift lever, within easy reach of the operator. It is properly operated by pressure of the thumb.

The starter is of an exclusive safety type that will not operate if the tractor is in gear. Therefore, when preparing to start, first make sure that the transmission is in neutral position.

Form the habit of holding the clutch pedal down when starting the engine. This relieves the starting motor of the extra work of turning over the transmission gears. This is especially important in cold weather.

Set the throttle four or five notches from the top on the quadrant under the steering wheel. Pull out the choke (on the dash) and hold *for an instant only*, at the same time pressing the starter button. In cold weather, slightly longer choking will be necessary.

After the engine starts, let it idle at low speed until thoroughly warm. Racing a cold engine or putting it to heavy work is like running it without lubrication, as the oil does not flow properly throughout the system until it is warmed. Working a cold engine also condenses combustion vapors into water, causing rusting and pitting of parts and the formation of sludge. All of these things hasten wear.

A good rule in cold weather is to idle the engine until fumes arise from the oil filler cap. This means that the moisture is being properly vaporized and is passing out of the engine. The thermostat in the upper radiator hose prevents water from circulating to the radiator while engine is cold. This shortens the warming-up period.

It is a good habit to glance at the oil pressure gauge on the dash as soon as the engine starts. If it should fail to register oil pressure at any time while the engine is running, stop at once, locate the trouble and correct it. Naturally, without oil circulation, serious and expensive damage to many moving parts is sure to occur very quickly.

It should be remembered, also, that this gauge registers oil pressure only. (This will be 15 to 30 pounds depending on temperature and engine speed.) The only way to make sure of the amount of oil in the crankcase is by daily checking with the engine oil level dip stick (see Lubrication Chart page 59).

Should the engine fail to start easily, check the following:

- (1) Tractor in gear.
- (2) Fuel tank empty.
- (3) Worn out, damaged, dirty, improperly set spark plugs or improper type of plugs.
- (4) Worn out or corroded distributor points.
- (5) Moisture in distributor.
- (6) Heavy oil in air cleaner.
- (7) Dirty air cleaner.



Keep gas tank full when tractor is not to be used for a day or two, to keep moisture from condensing in tank.

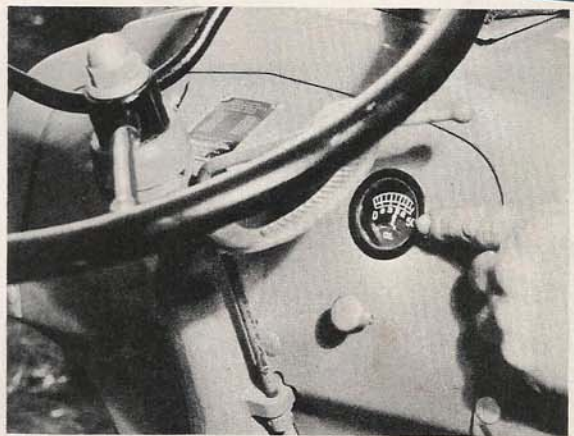

After starting engine, make sure oil pressure gauge registers.

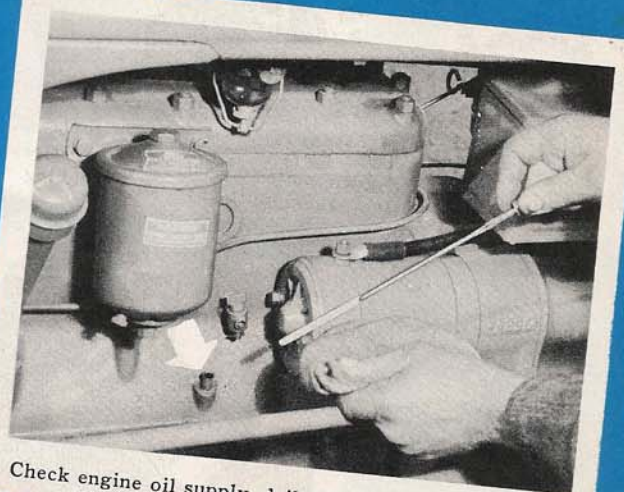

Check engine oil supply, daily, by examining dip stick.

- (8) Water in fuel system.
- (9) Plugged fuel line.
- (10) Carburetor out of adjustment.
- (11) Loose electrical connections.

Driving the Tractor

Hold the clutch pedal clear down and move the gearshift lever to the desired gear position. Open the throttle from four to ten notches, depending upon the load. Then let the clutch pedal come up smoothly and gently, for a smooth, easy start.

Never shift gears while the tractor is in motion as an accident or damage may result. Always stop, then start tractor in the gear in which you intend to work.

While the Ford Tractor Ferguson System needs no "petting", it will give more satisfaction and last longer if always operated within its rated capacity.

To speed excessively, or to overload, may seem to save time at the moment, but in the end, these are expensive habits. "Moderation in all things", is a good rule for tractor operation.

As a test for overloading, quickly pull down the throttle, as wide open as possible. If the engine picks up speed promptly, it is not overloaded. But if it responds slowly, the load is excessive and should be reduced.

Occasional temporary overloads, however, can be excused. It is the steady, long continued overload that shortens the life of a tractor.

Causes of Overheating

The tractor engine normally runs quite cool, hence any condition of overheating should be investigated immediately. Overheating causes uneven expansion of parts, resulting in loss of power, and, if continued, may cause complete stoppage, frequently with serious damage to pistons, cylinder walls, cooling system,



With clutch pedal down, shift to gear selected. Release clutch pedal slowly. Never shift gears while moving.

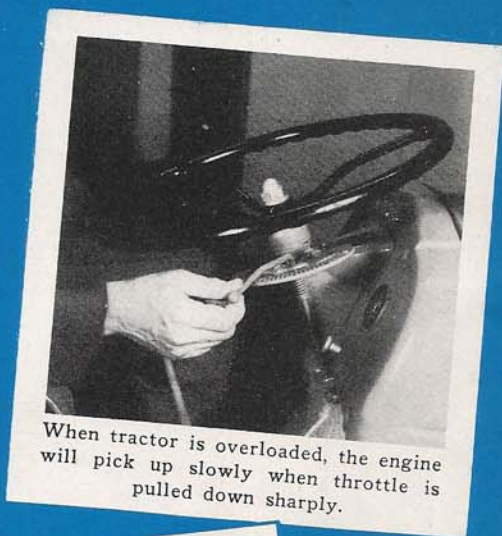

When tractor is overloaded, the engine will pick up slowly when throttle is pulled down sharply.

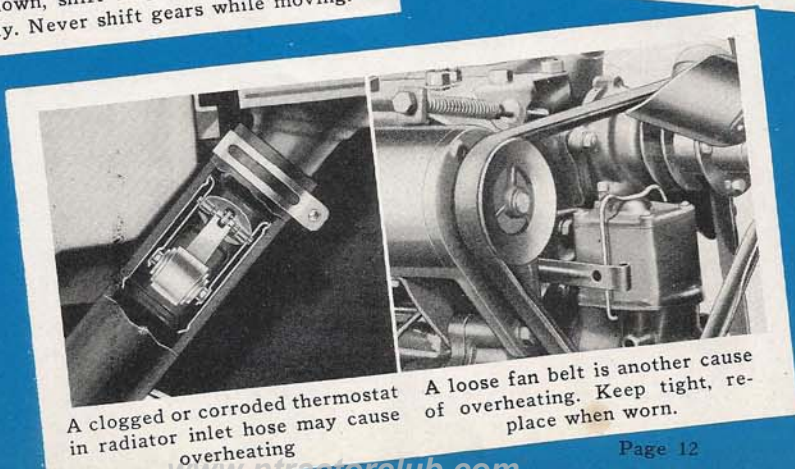

A clogged or corroded thermostat in radiator inlet hose may cause overheating

A loose fan belt is another cause of overheating. Keep tight, replace when worn.

etc. Any of the following conditions can cause overheating:

- (1) Not enough water in radiator.
- (2) Clogged radiator core.
- (3) Thermostat not working.
- (4) Too heavy transmission and differential oil, giving the same effect as an overload.
- (5) Water in cooling system frozen.
- (6) Loose fan belt.
- (7) Worn out or wrong type spark plugs.
- (8) Improper setting of spark advance.
- (9) Worn out ignition points.
- (10) Carburetor set too lean.
- (11) Long continued overload.
- (12) Dirty air cleaner.

To prevent overheating and possible damage therefrom, it is important always to use clean water in the radiator, as from a cistern or well. By checking the water level before leaving for the field, clear, clean water is always close at hand, if needed.

Causes of Excessive Fuel Consumption

The tractor engine is noted for its economical operation. Therefore, if at any time you feel that your fuel bills are too high, you doubtless will find that one of

the following conditions is the root of the trouble:

- (1) Improper carburetor setting.
- (2) Dirty air cleaner.
- (3) Worn out spark plugs.
- (4) Worn out ignition points.
- (5) Leaky connections between fuel tank and carburetor.
- (6) Too heavy oil in crankcase or air cleaner.
- (7) Letting tractor stand with engine idling for long periods.
- (8) Improper selection of gear for load.
- (9) Engine overheating.
- (10) Use of improper fuels.

When to Drive Slowly

Both for safety to the operator

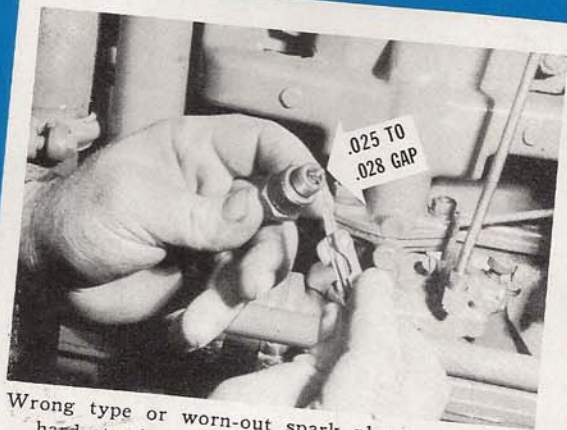

Wrong type or worn-out spark plugs may cause hard starting, overheating or waste of fuel.



Fill radiator with clear, clean water. Soft water is best.

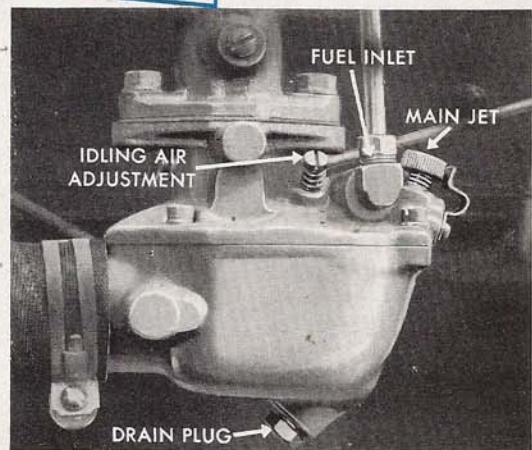

Fuel mixture too lean may cause overheating; too rich mixture wastes fuel.



Brake adjusting stem and how it expands or contracts brake shoe.

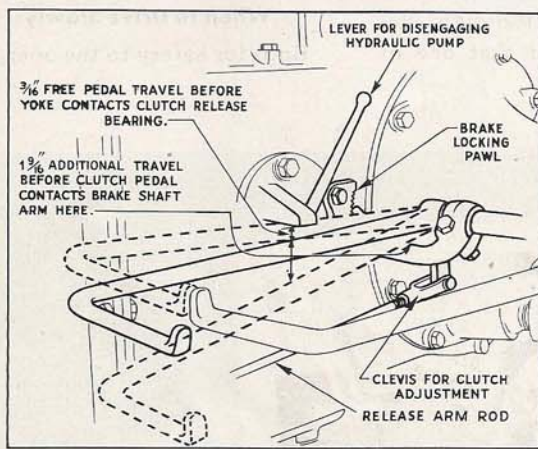

Drawing shows proper adjustment of clutch pedal.

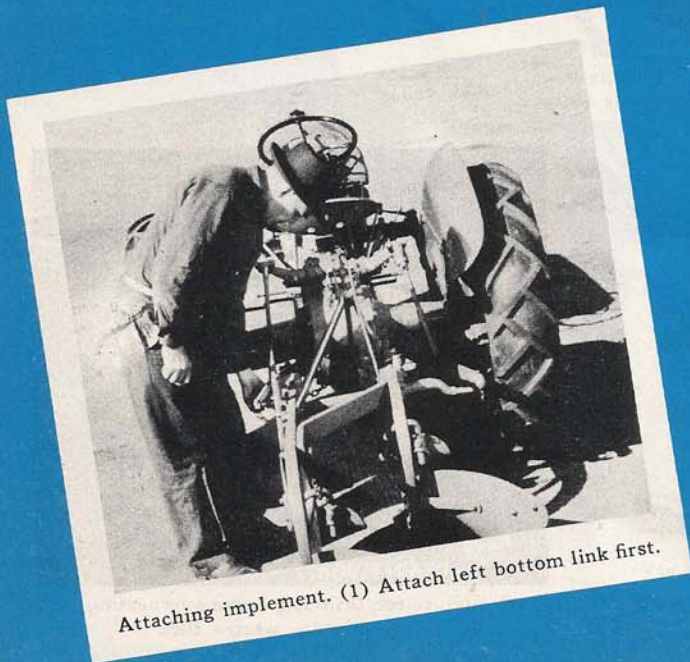

Attaching implement. (1) Attach left bottom link first.

and to prevent possible damage, it is a good idea to drive slowly:

- (1) When starting out in cold weather.
- (2) When working in rough ground or on steep grades.
- (3) When working fields that are full of obstructions.
- (4) When breaking in a new tractor.

Use of Brakes and Clutch

All that need be said here is that the more gently you can use your brakes and clutch the longer they will last, and the longer your tires will last. There is also less wear and tear on the entire mechanism.

The brakes should be applied equally (except when used for making turns). They are easily adjusted by turning the brake adjusting stem that projects from each brake housing. The rear of the tractor should be jacked up and the stem tightened until the wheel cannot be turned, then the stem should be "backed off" just enough so that the wheel revolves freely. This will usually be about $\frac{3}{4}$ of a turn. If this adjustment does not correct the operation of your brakes, see your Ferguson dealer.

The clutch pedal should have $\frac{3}{16}$ " of free travel and $1\frac{1}{16}$ " in addition, for disengaging the clutch. At this point the clutch pedal should contact the brake shaft arm and further downward movement of the clutch pedal should apply the left brake. To make any necessary adjustment of the clutch pedal, remove the clevis pin and rotate the release arm rod. Lengthening the rod increases the clutch pedal free movement; shortening the rod decreases the movement. Be sure to replace the clevis pin and cotter key after adjustment.

Hydraulic Pump, Quadrant, Control Spring and Linkage

The hydraulic pump, with its attachments and controls, is a



Attaching implement. (2) Attach right bottom link, turning leveling crank, if necessary.

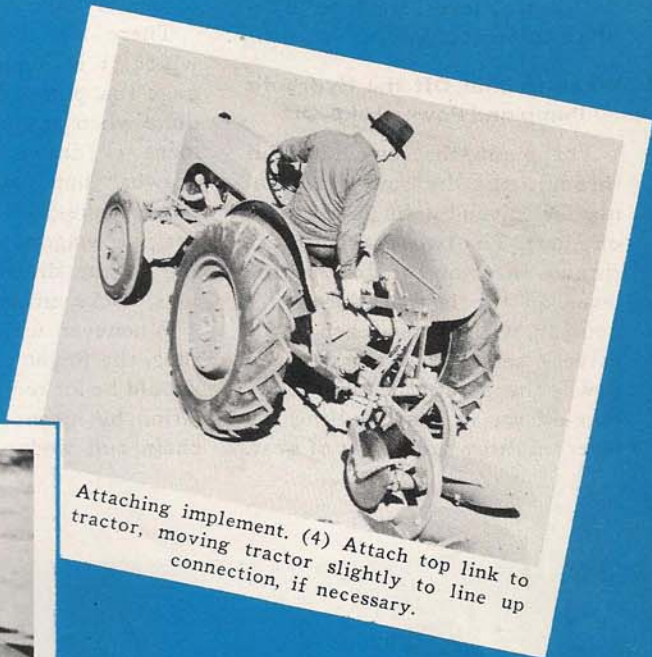

Attaching implement. (4) Attach top link to tractor, moving tractor slightly to line up connection, if necessary.

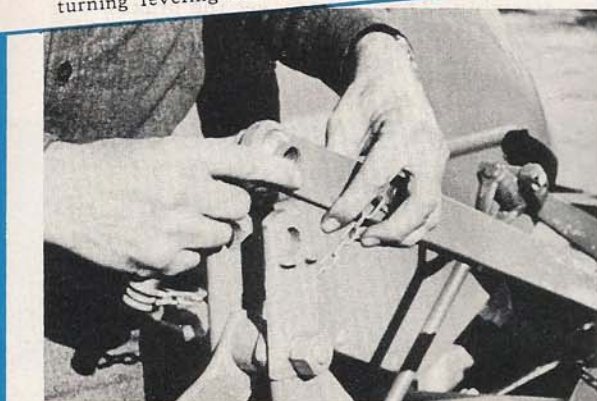

Attaching implement. (3) Attach top link to implement.

fine example of the efficiency of Ferguson engineering. Understanding its operation is as easy as A,B,C. Only a few simple precautions are in order, but these are important.

Attaching Implements

For example, when attaching a Ferguson Implement, it saves time to use the hydraulic and the linkage according to the following standard procedure:

1. Back the tractor so that it is centered with the implement.
2. Attach the left bottom link.
3. Attach right bottom link, using the leveling crank to bring the

ball joint in line with the connection.

4. Attach top link to the implement.
5. When seated on the tractor, attach top link to the tractor, moving tractor slightly backward or forward to line up connection for the front pin.

Detaching Implements

1. Level the implement with leveling crank, then lower on level ground.
2. While seated on the tractor, detach front end of the top link, moving tractor slightly backward or forward, if necessary, to free the pin at its connection.
3. Detach right bottom link, adjusting leveling crank to free any strain on ball socket joint.

4. Detach left bottom link.

IMPORTANT: Be careful to put the linch pins in their proper clips on the bottom links, to prevent the pins from being torn off.

Adjustment of Quadrant and Control Spring

The finger tip control quadrant and the control spring are properly adjusted at the factory, are rechecked by your dealer and should not be altered.

The finger tip control lever is held in place by a cork friction disc. In time, this may become worn, so the control lever will not retain its set position. But this is easily taken care of by

tightening, just slightly, the castellated nut at the lower end of the control lever. Be sure to replace the cotter key.

When to Shut Off the Hydraulic Pump and Power Take-Off

The pump that circulates oil through the hydraulic mechanism is driven by the power take-off shaft. The two, as a unit, are thrown in or out of gear by the lever on the left of the center housing, within easy reach of the driver's seat. When this lever is down, the pump and the power take-off are in gear. Pulling the lever up throws them out of gear.

Always hold clutch pedal down while putting power take-off into or out of gear.

There are two situations in which it is important to disengage the pump. This should be done when any pull type implement is drawn that uses the drawbar but does not use the power take-off—for example, a drag or wagon, or when chaining to the drawbar for moving logs, rocks, small buildings, etc.

Whenever using the drawbar thus, the finger tip control lever should be locked in the down position by means of the drawbar chain and wedge assembly. The

reason for this precaution is that if anyone should tamper with the finger tip control lever and cause it to operate the pump, serious damage might result.

The other situation is similar except that we have a drawn implement which requires the use of the power take-off—for example, a corn picker or combine. In this case, also, the finger tip control lever must be locked down, as explained above. And the power take-off should be thrown out of gear before dismounting from the tractor for any reason. In addition, if on a grade, set the brakes.



Tightening or loosening castellated nut adjusts tension of finger tip control lever.



Lever, on left of center housing, engages and disengages power take-off and hydraulic pump.

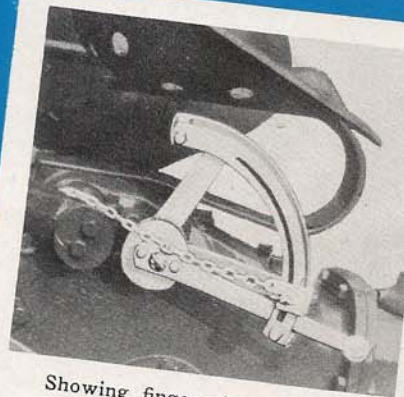

Showing finger tip control lever locked down by drawbar wedge and chain assembly.



For drawbar jobs that do not require power take-off, disengage pump and lock down the finger tip control lever.

Form the habit of always lowering the implements to the ground when tractor is left standing unattended. This will prevent accidental lowering by children or others who might accidentally move the finger tip control lever.

Using and Adjusting the Drawbar

When pulling implements that are not made for attaching with the Ferguson three-point linkage, and for dragging logs or other loads, the drawbar assembly must be used. This consists of the drawbar and the two adjustable stays that hold the linkage rigid and, by a bolt-and-slot adjustment, determine the height of the drawbar. The assembly is easily slipped into place and is held by the two (lower) linch pins and the one (upper) link pin. The standard setting of the drawbar is 18" above the ground.

Under no circumstances should an attempt be made to raise or lower the drawbar by means of the finger tip control lever, as injury or damage may result. In fact, the first step, when putting on the drawbar, is to lower the linkage, install the stay assembly, and lock the finger tip control lever in the down position with the drawbar chain and wedge assembly. Then disengage the hydraulic pump unless the power take-off is to be used. In other words, any adjustment of drawbar height should be made by shortening or lengthening the drawbar stays, *and not by raising or lowering it with the finger tip control.*

Again for safety, and to prevent possible damage, *never* pull from the drawbar without having the stays in place.

Another worth-while caution is against letting anyone ride on the drawbar (or anywhere else on the tractor except in the operator's seat). The tractor is pur-

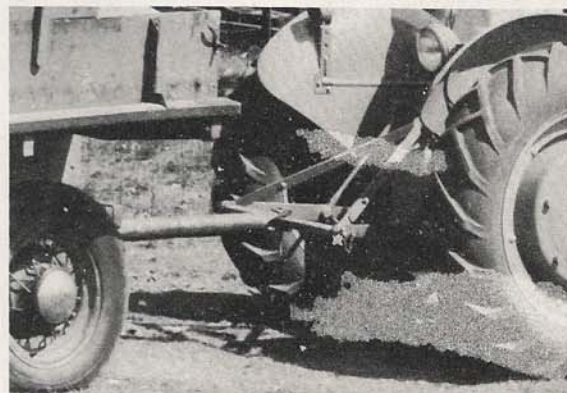

Never pull from top link connection. Attach pulled implements, log chains, etc., to drawbar only.





With tractor on Ferguson Power Jack, wheel spacings are easily changed.

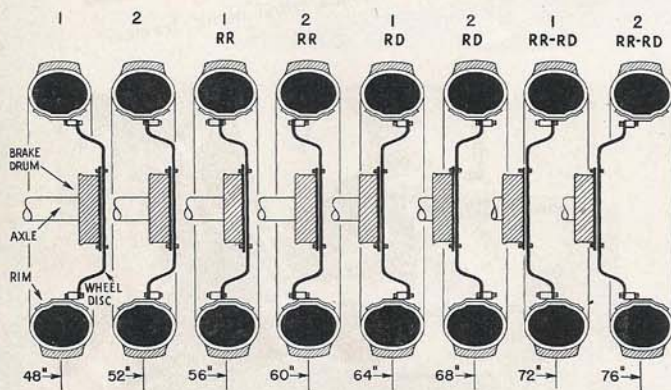

Key to code (above drawing), showing rear wheel tread adjustment.

- 1—Means wheel disc is mounted to the outside of the wheel rim.
- 2—Means disc is mounted to inside of rim.
- RR means reverse rims, inside out, and to opposite wheels.
- RD means reverse discs, inside out.

posely streamlined to discourage the practice of hauling riders, which frequently results in accidents.

WARNING! Never Pull From Top Link Connection

Safe tractor operation is urged at all times. If all the pull is centered at one point well above the rear axle, the control of the tractor may be lost. Therefore, to prevent any possibility of accident, always pull from the drawbar. *Never pull from the top link, the master control spring rocker levis or from the axle housing under any circumstance.*

Keep Linkage Clean But Do Not Lubricate

The ball joints of the linkage should not be lubricated, as this would cause dust and grit to collect at these points, resulting in undue wear. Keeping these parts clean and bright is all the attention that they require.

Changing Tread Widths

The gauge of the rear wheels is adjustable by assembling the discs and rims in different relations. This is easily done with the aid of the Ferguson power jack.

Treads of 48, 52, 64, 68 inches are made without changing rear wheels to opposite sides of tractor. Treads of 56, 60, 72, 76 inches require switching wheels to opposite sides to keep the tire tread traveling in the right direction. Note: Arrow on side wall of the tire must always point in direction of travel.

The front axle is made in three parts and the tread is adjustable from 48" to 72" by assembling to the proper lengths. Additional width from 72" to 76" is obtained by reversing the front wheels (so the "inside" face of each wheel is turned out).

Caution: Loosen the bolt through the radius rod yoke first, then spread the axle as desired. No change in the steering mech-

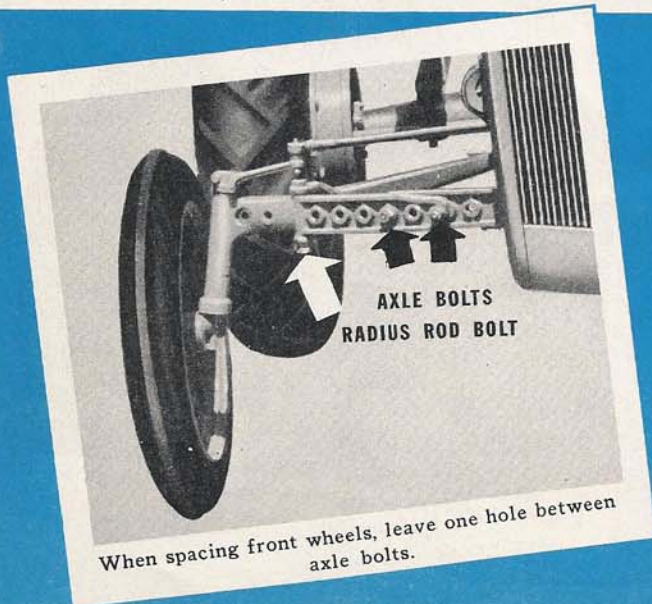

When spacing front wheels, leave one hole between axle bolts.

anism is necessary, an exclusive Ford Tractor Ferguson System feature. Always assemble the axle with *one* hole between the bolts holding the two parts together; never put the bolts in adjacent holes.

Except for cultivating row crops, changes in wheel tread widths are rarely necessary. A good general rule is to space the wheels as closely together as the work to be done will permit, as this results in the least possible strain on the tractor.

Some Safety Rules

In the opinion of many farmers, the Ford Tractor Ferguson System is the safest mechanical power unit ever built. However, there are a few simple safety rules which every operator should know:

- (1) One man is enough on a tractor at one time. Avoid carrying riders.
- (2) Never pull from the top link connection.
- (3) Always use drawbar stays with the drawbar.
- (4) Lock down the finger tip control lever when using the drawbar. And disengage the hydraulic unless the power take-off is needed.
- (5) When using the power take-off, always disengage it before dismounting from tractor.
- (6) Keep power take-off universal joints well shielded.
- (7) Drive slowly in difficult going and avoid "jerky" operation at all times.
- (8) At high speed, do not try to turn sharply by applying one brake.
- (9) Keep a new tractor on light work for fifty hours.
- (10) Do not carry anything or anybody on the implement.
- (11) If radiator is hot, loosen the cap carefully until pressure is reduced before removing the cap.
- (12) To avoid accidents from static electricity when using belt and pulley, make a metal connection or "ground" from the metal of the tractor to the ground (into damp earth if possible). This can



Keep power take-off universal joints well shielded.



Set brake locking pawl before dismounting on a grade, and for belt work.

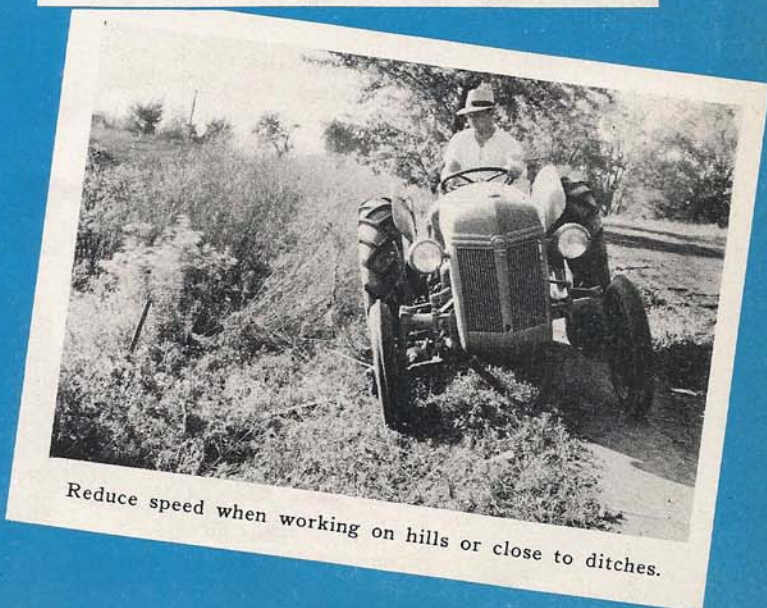

Reduce speed when working on hills or close to ditches.

be done by driving an iron bar or pipe into the ground with its upper end in contact with any metal part of the tractor.

- (13) Never try to put on, or take off, a belt while the pulley is in motion.
- (14) Put transmission into lower gear before descending a steep hill and do not attempt to change gears while on a hill. Never "coast".
- (15) Set brakes securely before dismantling from tractor on a grade.
- (16) Form the habit of shutting off the engine before making any adjustments to driven equipment.
- (17) "Ground" the supply tank in which tractor fuel is stored

as a protection against possible static electricity.

- (18) When on public roads, watch out for automobile traffic and use arm signals before turning or stopping. Equip with lights for driving on the road at night.
- (19) Use extra care when working on hillsides or close to ditches.
- (20) Never refuel tractor while engine is running or extremely hot.

Better Plowing the Ferguson Way

A Ferguson Plow, operated by the Ferguson System, makes possible the nearest thing to

automatic plowing that farmers have ever known. Some of the operation, in fact, is automatic. And the rest is accomplished with such effortless ease that now young or aged people can plow as well as a man in his prime.

There is nothing complicated about this plow, and, therefore, nothing difficult to understand about it. How simple and easy it is to operate and care for, compared with the usual wheel plow, is clear when we see how many things this plow gets along *without*.

For example, it gets along with about 400 pounds less weight than the average 2-bottom plow.

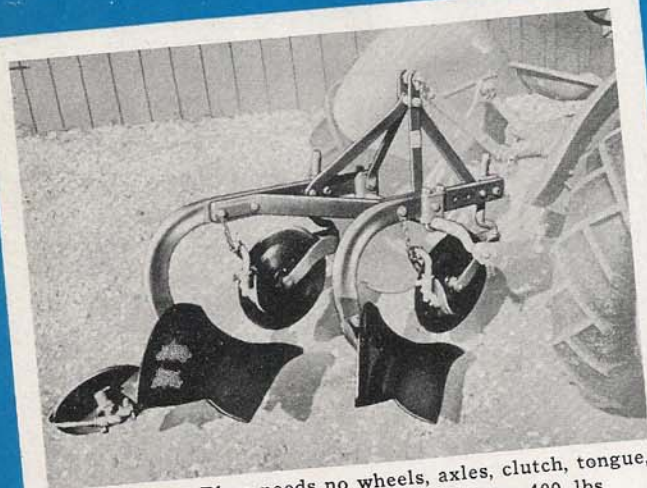

The Ferguson Plow needs no wheels, axles, clutch, tongue, "safety hitch", levers or springs. Saves 400 lbs.

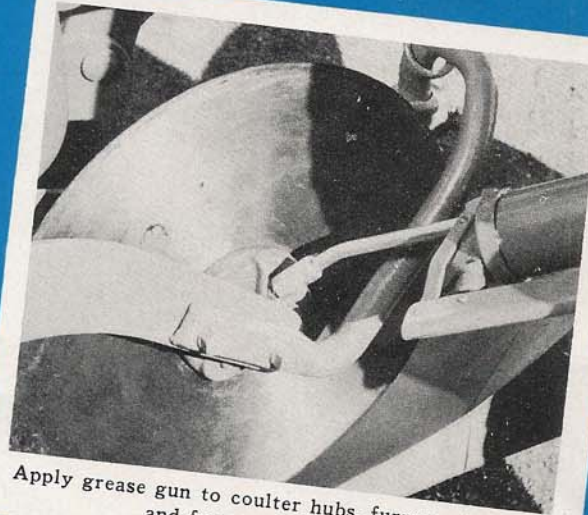

Apply grease gun to coultter hubs, furrow wheel hub and furrow wheel bracket.

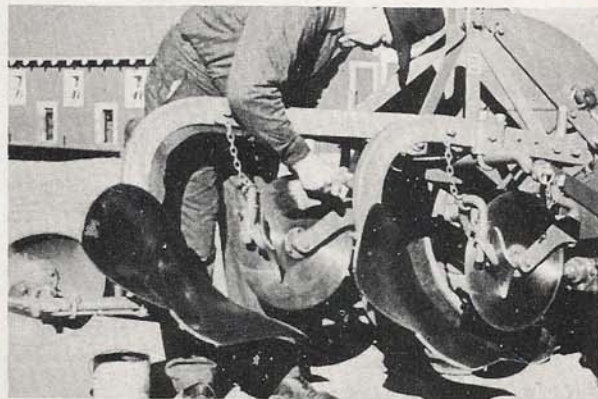

Factory-applied paint or varnish should be removed from working surfaces with paint remover.

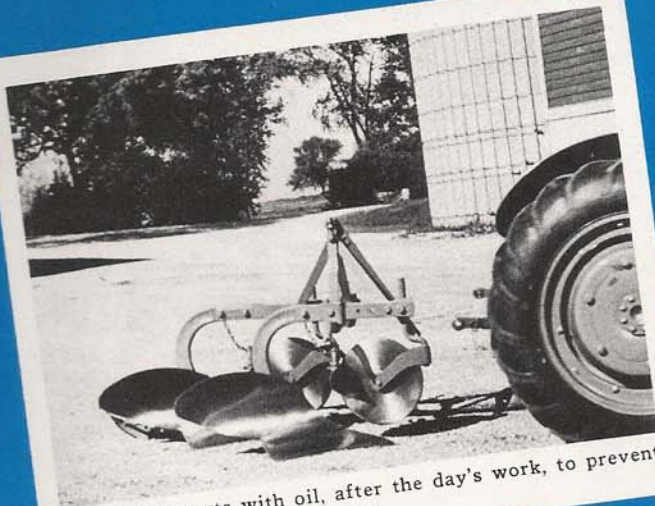

Coat bright parts with oil, after the day's work, to prevent rust.



Headland furrow. Use rear base only. Plow 2" to 4" deep.

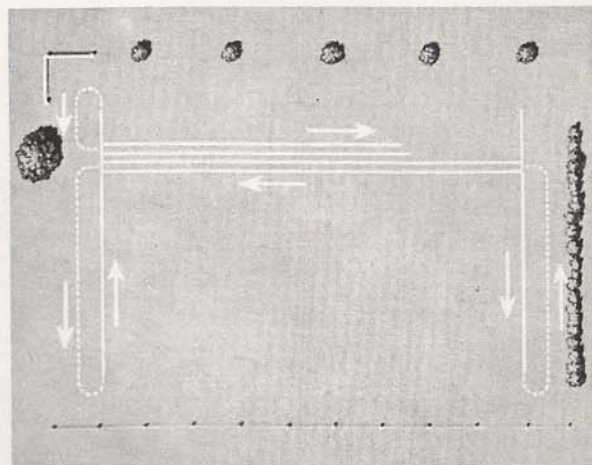

One way to open a land. Single lines are headland furrows (made with rear base only). Double lines are back furrows. Dotted lines are turns, driving "empty".

It gets along without wheels or axles. It gets rid of bothersome rope-operated clutches. It has no tongue and needs no "safety hitch". It has no levers or springs of any kind.

It has, in fact, nothing to get in the way of doing a mighty fine job of plowing; so that is exactly what it does.

Operating suggestions come under two very simple heads: (1) adjustments on the plow itself, such as coulters, jointers, width of cut, etc., and (2) some handy ways of working a field. These, and the usual details of greasing, rust prevention and

sharpening, are all that anyone needs to know about plowing.

Getting the New Plow Ready

For protection against rust, while the new plow is on its way to the farm, the factory has applied a coat of paint or varnish to all bright parts—shares, moldboards, landsides, jointers, coulters, furrow wheel and cross-shaft connections.

To get good operation right from the start, the paint on these parts should be removed, instead of relying on it to wear off. Any commercial paint remover will take it off quickly. (Use care not

to get the paint remover on beams, shaft and other non-working parts which you will want to keep painted for good appearance and for protection against rusting.)

Thereafter, the moldboards and other bright parts should be cleaned and lightly oiled at the end of each day's plowing to prevent rusting.

When storing the plow, cover all bright parts with heavy grease or commercial rust preventive compound.

Attaching the Plow

This is the usual Ferguson



Starting back furrow. Back furrow should be comparatively shallow, made with both bases, but with front base set about half as deep as rear base.



Completing back furrow. Use headland furrow as marker for lifting plow.



Preparing to make a right turn for starting regular furrows.

System, 3-point method of attaching and needs no explanation here, as it is fully covered under "Tractor Operation" (see page 15).

Before starting to the field, grease the bearings by applying the grease gun to the fittings located on couler hubs, furrow wheel hub and furrow wheel bracket.

As plowing conditions affect the adjustments required, it is advisable to leave any fine adjusting of the plow until after arrival at the field.

Note: A handy thing in the toolbox is a folding rule for use

if it should be necessary to measure and adjust the width of cut, in the field, as will be explained later.

Opening the Field

Every farmer will have his favorite method of plowing and, whatever that method is, the flexibility of the Ferguson System permits the finest possible operation. For example, here is how it works when opening a land by means of a headland furrow across each end, then plowing out from a central back furrow that connects the two headland furrows. (Note: It is advisable, however, to plow

"in" instead of "out" when the same field is plowed again.)

A little forethought in laying out a field will more than pay in time saved in plowing and in better quality of work. Good plowing is the basis of good farming, and it is impossible to correct poor plowing by discing or harrowing.

For example, it is well to step off distances and mark them with stakes. In locating the first headland furrow, step off a strip wide enough on which to turn at each end of the field. These make the headlands. Now divide the field into convenient width "lands", then step off and stake out a line

down through the exact center of the first land you want to plow. This center line will be the place for the back furrow.

Having staked out the land, adjust your plow so that a shallow furrow (2" to 4" deep) will be made by the rear base only. This is done with the leveling crank, by raising the front base. With this adjustment made, get into position to make the first headland furrow.

Then lower the plow and make this headland furrow along the line you have staked out across the end of the field, making sure you throw the dirt *into* the land to be plowed. That is, drive as you would if you expected to make right turns around the field, but plow only across the end.

The purpose of the headland furrow is to permit even entries and finishes, and to leave a straight edge to help in plowing the headlands (the last part of the plowing job). It is, in fact, a marking furrow only.

After putting in the first headland furrow, lift the plow, turn left on your headland, and head back to the long center line that you have staked out. Along this line, plow the first half of the back furrow. This should be a comparatively shallow furrow, but made with both bases, the front one cutting only about half as deep as the rear base. The leveling crank makes this adjustment easy.

At the line that you have staked out for your second headland furrow, lift the plow and swing around to the left to the edge of the field. Adjust the plow for a shallow cut by the rear base only and put in the other headland furrow, just as you made the first one.

At the end of this last headland furrow, lift the plow and make a left turn on the headland



The regular furrows. Both bases set at same depth.



Full-width furrows, straight from one end of the field to the other, are made by keeping right tractor wheels against the furrow wall.



Plow is leveled or tilted, without stopping, by turning leveling crank.

time. While the speed at which you are plowing will make a difference, in general, the plow should be raised or lowered just as the rear tractor wheels cross over and leave the headland furrow.

Always reduce speed when entering and leaving headland furrows.

Making Both Furrows Alike

An occasional glance to the rear will tell whether or not the furrows are even. If they are not, the fault is easily corrected without stopping, by turning the leveling crank to level the bases.

Quadrant Stop Marks Depth

As soon as you have determined how deep you want to plow, fasten the quadrant stop in place with the wing nut. This will stop the finger tip control lever at the same spot each time you lower the plow. Yet it is easy to set the lever either below the stop, or short of it, if necessary, to offset soil changes in the field, thus maintaining uniform depth.

Adjusting Coulters for Clean Furrow Walls

The coulters cut ahead of the shins of the moldboards, saving

wear on the moldboards and lightening the draft. They keep the upper edges of the furrow walls sharp and vertical.

Usually the coulters should be set so they are about three-quarters of an inch to the left of the landsides, and with about an inch and a quarter of clearance above the nearest part of the shares. Too low an adjustment will make the implement ride on the coulters hubs and may even cause excessive slippage of the tractor wheels. It is good practice to raise the coulters above these settings under the following conditions: (1) plowing in

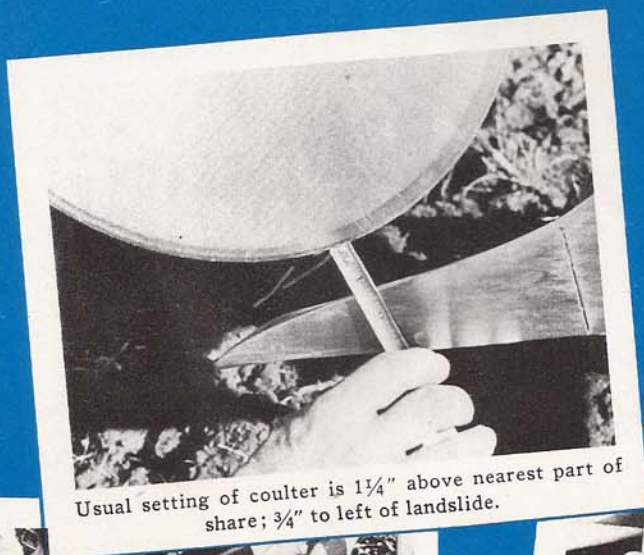

Usual setting of coulters is $1\frac{1}{4}$ " above nearest part of share; $\frac{3}{4}$ " to left of landside.

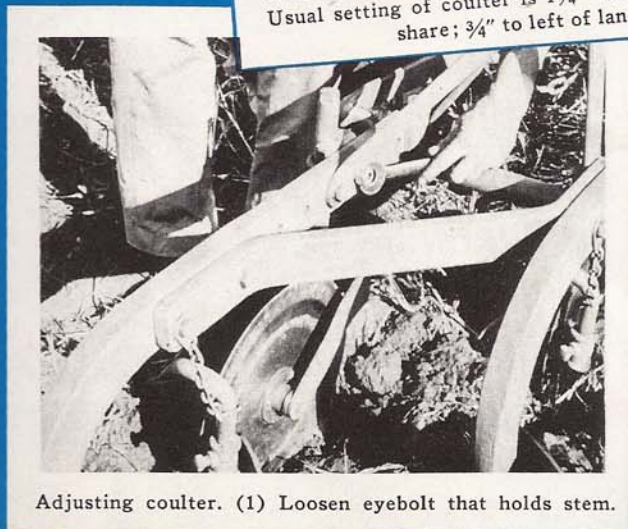

Adjusting coulters. (1) Loosen eyebolt that holds stem.



Adjusting coulters. (2) Raise or lower stem or revolve it to right or left, as required.

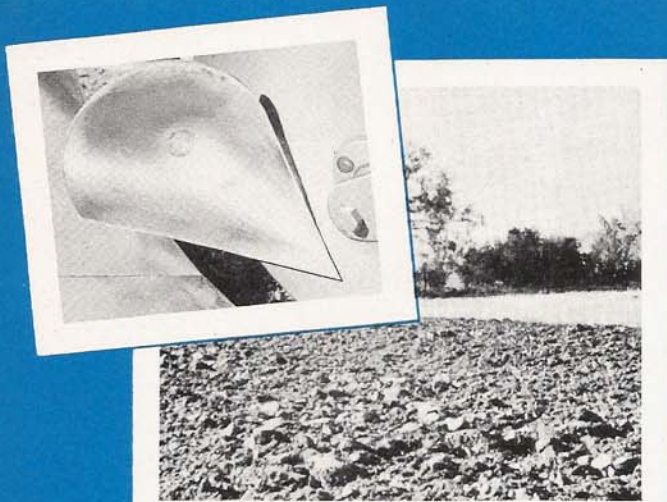

Jointers should be set with point lightly touching coulters blade, and should cut $\frac{3}{4}$ " to 1" into edge of furrow slice.

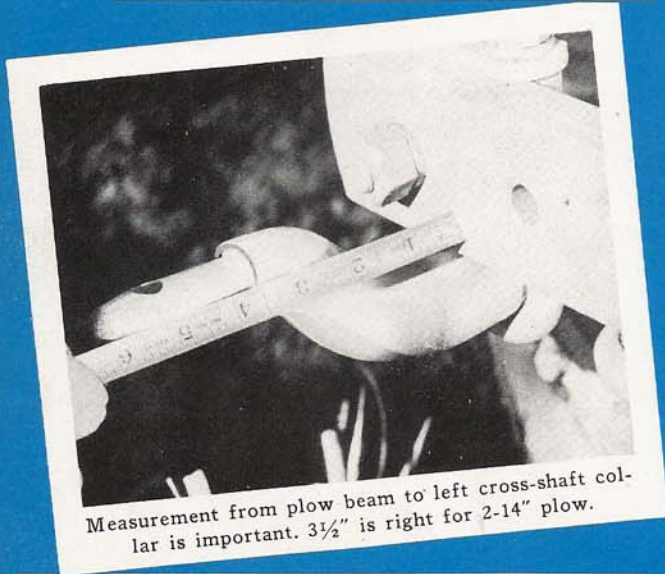

Measurement from plow beam to left cross-shaft collar is important. $3\frac{1}{2}$ " is right for 2-14" plow.



Width of cut is measured from furrow wall to front coulters.

hard ground, (2) in trashy conditions, (3) stony ground, (4) when plowing unusually deep.

Setting the coulters too far out, or in, will increase draft and cause unevenness in the furrow walls. Coulters too far in cause torn and ragged walls. A coulters too far out will cause an offset in the furrow wall and result in poor work.

Coulters adjustments are easily made by loosening the eyebolts that hold the stems, moving the stems as required, then tightening the eyebolts.

Coulters check chains prevent the coulters from swinging into tractor tires when plow is in transport position. If jointers are not used, jointer standards to which the check chains are attached should be left on the plow.

Correctly Set Jointers Bury the Trash

Just as the coulters "helps out" the moldboard shin by cutting a clean upper furrow wall, so the jointer "helps out"—by doing a small job of plowing on the edge of the furrow slice. The purpose of this job is to cut in slightly and roll the surface grass, weeds or trash over into the furrow, there to be covered by the clean earth that rolls off the moldboards.

When jointers are not working properly, grass and trash may not be properly covered. Improperly covered vegetation may take root and continue to grow. Jointers usually should be set to cut from three-quarters of an inch to an inch into the edge of the furrow slice. The jointer point should lightly touch the coulters blade, but with the upper part $\frac{1}{2}$ " from the coulters disc.

Varying field conditions make it impractical to give exact coulters and jointer recommendations.

Some experimentation is usually required, and the time thus spent will be well repaid.

Correcting Width of Cut

The width of the cut of the front base is determined by measuring from the edge of the furrow wall to the front coulter. This measurement should be made on level ground.

Incorrect width of cut may result from not keeping the tractor's front wheel close to the furrow wall, from improperly adjusted coulters, from failure to keep the plow properly leveled, or from a change of the "lead-in" of the plowshare when resharpened.

If the trouble is not due to one of these causes, it may be due to faulty adjustment of beams on the cross-shaft, which can be checked and corrected in the following way:

First, using a ruler, measure the distance from the left plow beam to the cross-shaft collar. (See illustration, page 26.) For various size plows, this distance should be:

- For 2-14" plow..... $3\frac{1}{2}$ "
- For 2-12" plow..... $7\frac{1}{2}$ "
- For 2-10" plow..... $9\frac{7}{8}$ "
- For 1-16" plow..... $8\frac{7}{8}$ "

If this distance is found to be incorrect, loosen the U-bolts that

hold the beams on the cross-shaft, move beams to correct position and retighten the U-bolts evenly.

If this adjustment does not correct the trouble, make the following adjustment after backing about a foot to take the strain off the plow bases.

- (1) Place a mark around the cross-shaft at the edge of either beam. (This is to guard against shifting the beams sidewise on the shaft during the adjustment.)
- (2) Place a dot or straight mark on the beam and another directly in line with it on the cross-shaft (to measure turning adjustment about to be made).

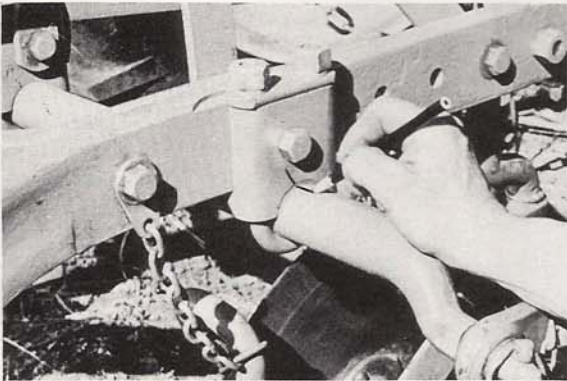

Adjusting width of cut by turning cross-shaft. (1) After backing the tractor to relieve tension, mark cross-shaft and beam, as shown.

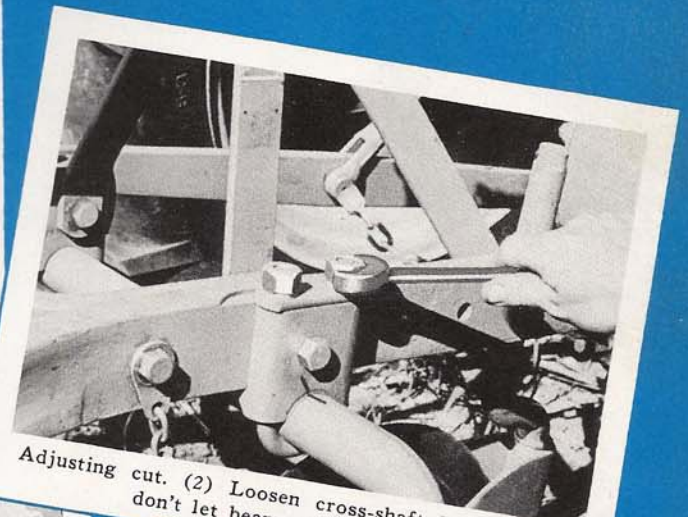

Adjusting cut. (2) Loosen cross-shaft U-bolts, but don't let beams shift sidewise.

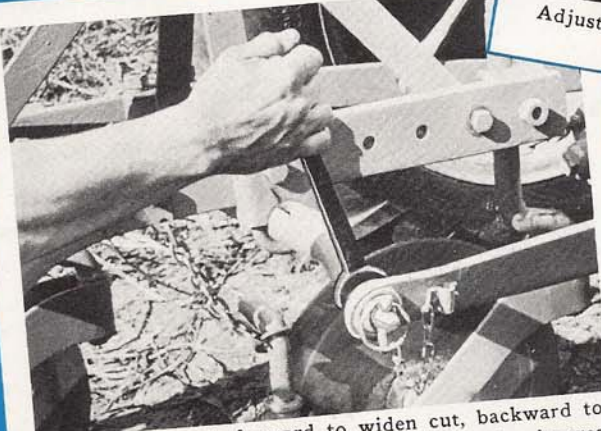

Rotate cross-shaft forward to widen cut, backward to narrow the cut. A movement of $\frac{1}{8}$ " at the marks changes width of cut 1".

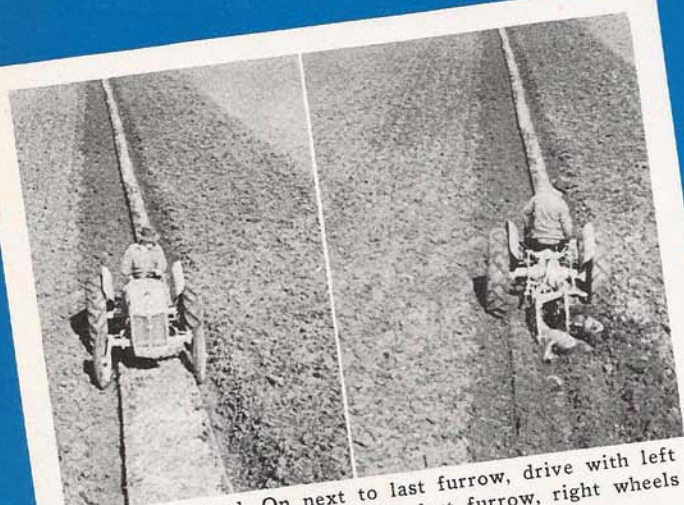

Finishing a land. On next to last furrow, drive with left wheels against furrow wall. On last furrow, right wheels are against furrow wall.

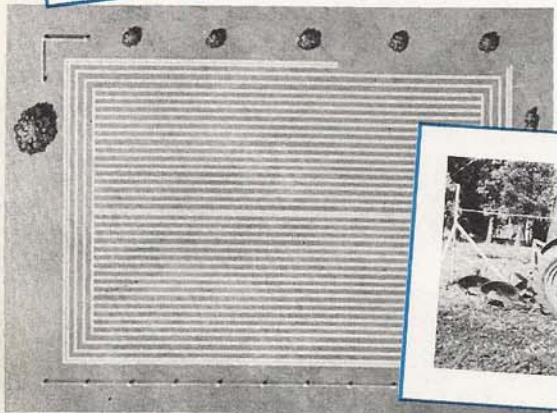

Plowing headlands. Easy turning and backing makes it possible to finish out corners neatly.

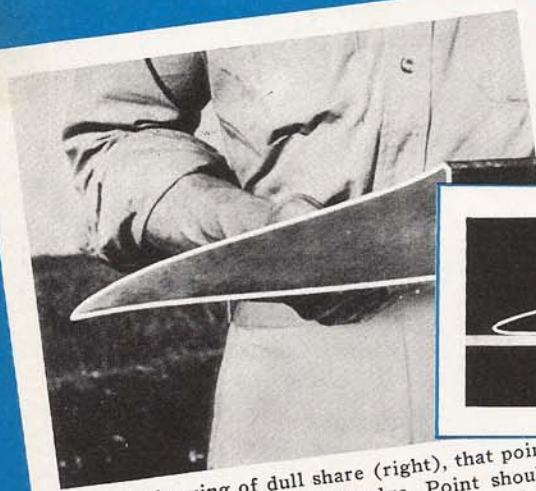

Note, in drawing of dull share (right), that point rises up, away from straightedge. Point should have slight downward suck.

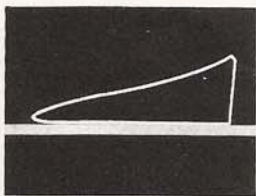

(3) Loosen the U-bolts that hold the beams. Without permitting the beams to shift sidewise on the cross-shaft, rotate the cross-shaft by using the wrench on the squared end. Watch the marks you have made on beam and cross-shaft. A turn of the shaft one-eighth inch *forward* will *widen* the furrow cut by one full inch. A turn of one-eighth inch *backward* will *narrow* the cut by an inch. (Never try to make this adjustment by moving the beams on the cross-shaft as hard draft, wear and poor work will result. Tighten U-bolt nuts evenly.)

Another condition that may affect the width of cut is extreme variation in soil texture or condition.

Finishing the Land

When the unplowed strip of land becomes so narrow that the tractor straddles it, lower the front base slightly. This is to level the plow, and is necessary, as the left wheels are now in the furrow. Now drive with the *left* wheels instead of the right wheels against the furrow wall, plowing as shallow as possible while still turning the soil. This will leave only a narrow strip to be finished the last time through the field.

Then, with the leveling crank, raise the front base well above the usual working position and drive as usual with the *right* wheels against the furrow wall. The remaining land will thus be turned by the front base. (With the 2-12" plow a narrow strip also will be turned by the rear base.)

By following this system it is easy to make neat, shallow dead furrows which will not interfere with subsequent field operations.

Plowing the Headlands

After a field has been plowed except for the headlands, it is easy to finish these by plowing in the same direction as the original headland furrows. At the

end of each cut it is only necessary to raise the plow, make the turn and proceed with the next furrow. This same flexibility, used in small fields, gardens and truck patches, makes it possible to plow all corners, close to the fences.

Importance of Well Sharpened Shares

Many plowing troubles are caused by worn or poorly sharpened shares. A properly sharpened share should have a point that dips down—leaving a slight up-curve along the bottom edge. This assists in providing pene-

tration. When worn, so that a straight edge along the bottom will not touch the extreme end of the point, penetration may be faulty.

It is a good idea to keep one or more extra sets of well-sharpened shares on hand. This habit saves time and money during the rush of the plowing season. With extra shares, it is unnecessary to drive to town and wait for a busy blacksmith to sharpen a dull set before plowing can be resumed.

Weedhooks

A set of Ferguson Weedhooks should be on hand for use when

plowing under heavy cover crops, tall weeds and similar heavy vegetation. These hooks will help materially in doing a good covering job under such conditions. They are easily and quickly attached or detached.

The Tandem Disc Harrow

The disc harrow has always meant heavy, tedious work—tiresome to man and a severe, constant, wearing load on a tractor. Application of the Ferguson System, however, changed all this, and provided an easy and effective means of controlling



Attaching disc harrow. (1) Lower linkage with finger tip control lever, then attach lower left link.

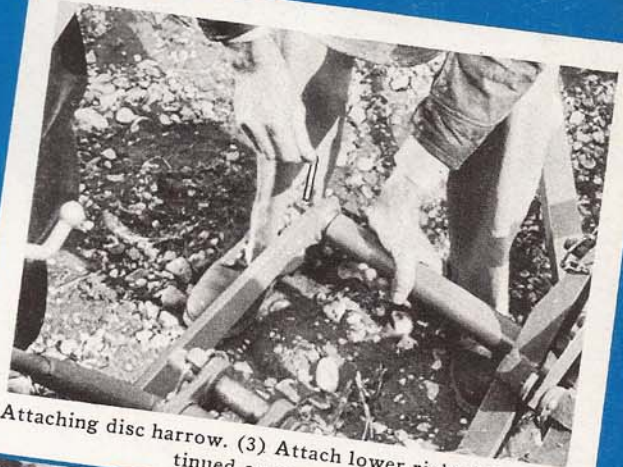

Attaching disc harrow. (3) Attach lower right link (continued on next page).



Attaching disc harrow. (2) Turn leveling crank so that notch on threaded lift rod just shows.

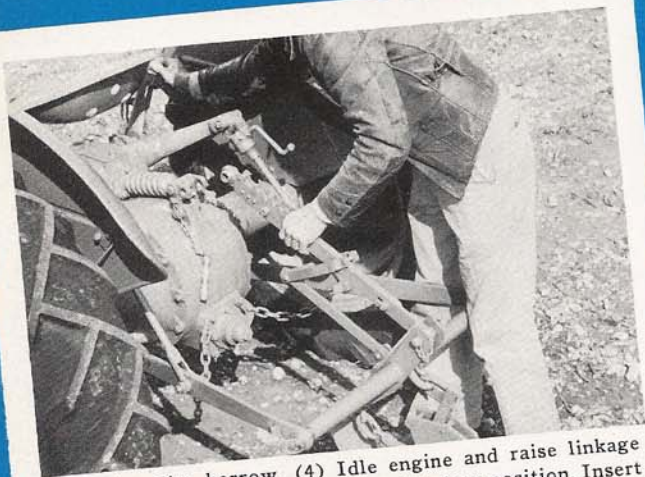

Attaching disc harrow. (4) Idle engine and raise linkage with finger tip control to bring top link into position. Insert link pin.

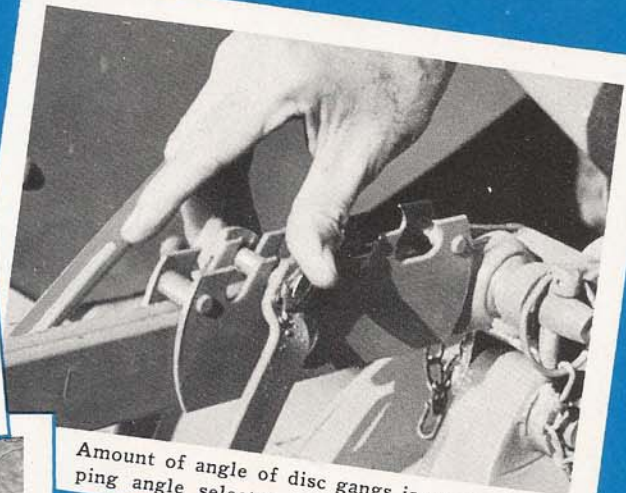

Amount of angle of disc gangs is set by dropping angle selector yoke into desired notch.



Lubricate bearings twice daily, oftener under extreme dust conditions.

the disc harrow under all conditions of operation.

Among many advantages are better quality of work, faster operation, greater ease of handling and periodic load relief on the tractor. This is largely brought about because the operator can now sit on the tractor seat and without stopping, or even looking around, put the angle into the disc gangs or take it out, by a finger tip touch on the hydraulic control lever.

Ferguson System advantages will become apparent as you read how each operation of the Ferguson Disc is managed.

Attaching the Ferguson Disc

Back the tractor up, centered to the disc, and lower the bottom links by moving the finger tip control lever down. Attach the left bottom link first. Then make sure the right bottom link of the tractor is level with the left bottom link by turning the leveling crank to where the notch on the threaded lift rod just shows. Then attach the right bottom link.

With the engine idling, slowly move the finger tip control lever toward the top position. This will gradually raise the bottom links, at the same time, lifting the top

link until it comes into correct position. Then insert the pin in the top link.

Lubrication

Before starting for the field, grease the bearings with the tractor grease gun. This should be done twice daily, and oftener under very dusty conditions. It lengthens the life of the bearings by keeping them clean and lubricated, reduces draft, and hence saves fuel and wear on the tractor.

Road Precautions

On the way to and from the

field, the operator will, of course, have the discs set to travel straight. To obtain this setting, simply see that the finger tip control lever is in fully raised position.

Hard-surfaced and graveled roads are the disc's worst enemy. Because the blades are thin and highly tempered, such unfavorable conditions readily cause dulling. Therefore, avoid hard roads as much as possible. If there is room, travel along the shoulder of the road; if not, at least drive slowly.

Some farm operators rig up low wheels or platforms on which to transport their discs.

Form the habit, when discing, of driving around, and not over, any outcroppings of rock, or at least pass over such obstructions with discs straight and at very low speed.

Selecting the Angle

On the top link, within easy reach from the tractor seat, is the notched angle selector. Placing the movable yoke in any of the notches determines the angle that the disc gangs will take when the finger tip control lever is moved down. The notch nearest the seat gives the smallest angle; the notch farthest back from the seat gives the largest angle.

When putting a new disc into use, it will start scouring more quickly if paint or varnish is first removed from the blades.

Changing Angle of the Rear Gang

The rear gang adjusting pin should be placed in the third or fourth hole for average conditions. The amount of angle that the rear gangs will take can be increased or decreased by transferring this pin to a different hole. But, as a general rule, the rear gangs should be operated at

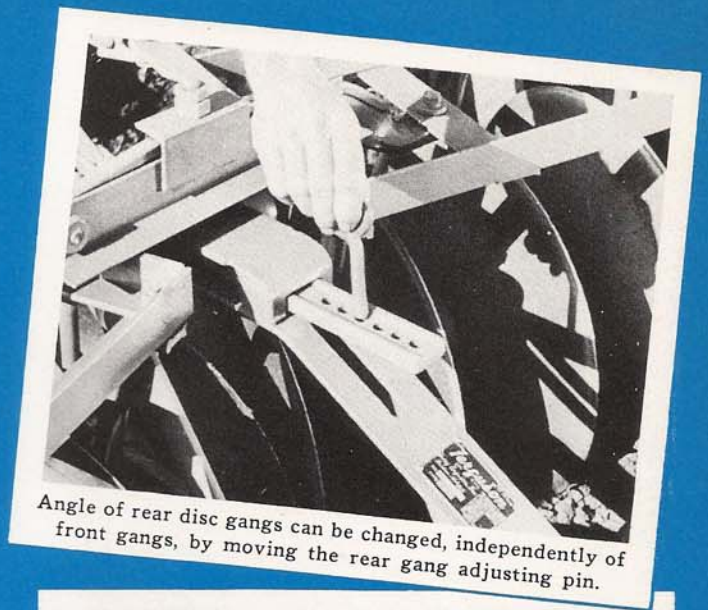

Angle of rear disc gangs can be changed, independently of front gangs, by moving the rear gang adjusting pin.

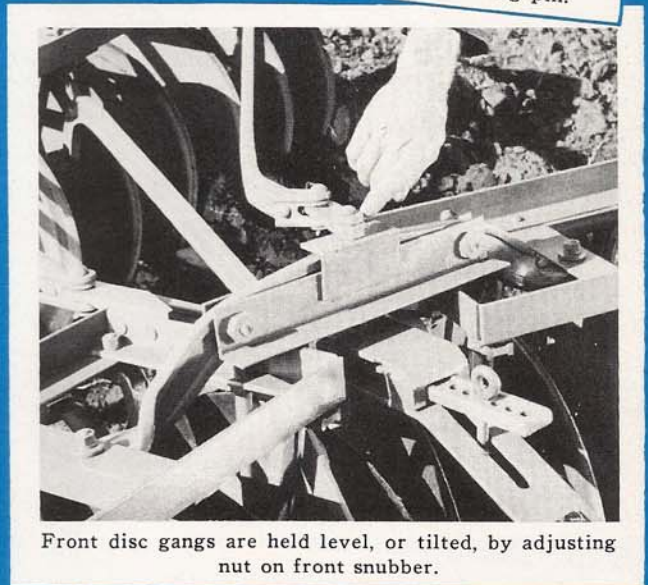

Front disc gangs are held level, or tilted, by adjusting nut on front snubber.



Rear gangs snubber is adjusted by set screws. Tighten center bolt when adjustment is completed.



By use of the finger tip control lever, operator is about to straighten disc gangs for making turn.

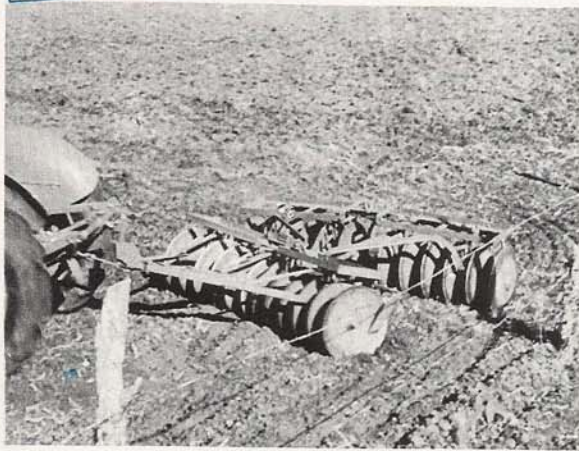

Making turns, with disc gangs straight, saves fuel and prevents ridging the soil.

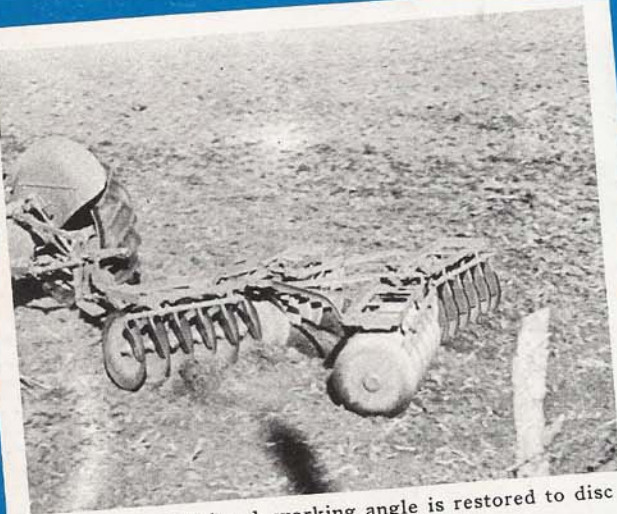

With turn completed, working angle is restored to disc gangs by finger tip control.

only enough angle to level the soil. Ordinarily, they should be somewhat straighter than the front gangs.

The Ferguson Snubber Control

This is a valuable Ferguson feature because these snubbers (one for the front gangs and another for the rear gangs) make the disc gangs run level.

At the center of the front snubber is an adjusting nut. Turning this nut down will cause the outer ends of the gangs to ride higher. Backing the nut off will lower the outer ends. A similar adjustment of the rear snubber can be made, but here set screws, instead of an adjusting nut, are used for the purpose. After adjusting, lock the rear gangs in position by tightening the center bolt.

Use of the Finger Tip Angle Control

It is almost like magic the way the gangs of a Ferguson Disc take the angle and, a moment later, by finger tip control, straighten out, then go back to working again—all at the will of the operator, "as simple as pushing a button".

It is easy to see how much this saves the operator's time and strength. There is another big advantage, too, for the setting and straightening of the disc gangs with convenient finger tip control actually saves fuel and wear on the tractor. This is how:

Discing, ordinarily, is harder on the tractor than any other farming operation. The reason is that the tractor gets practically no rest from the steady, hard pulling. Moreover, it is usually so awkward to straighten the angle of the gangs that it is simply set and left in throughout the job. This means that every turn around, at each end of the field,

puts an *additional* load on the tractor.

But, with the Ferguson System, control of the angle is so quick and easy that the operator can "rest" his tractor by straightening the disc angle on turns. Just this amount of regular relief makes the tractor more efficient, reduces wear and tear on parts and tires; and it saves fuel, too.

The practice of straightening the disc angle when turning also prevents over-discing and ridging of dirt at the ends of the field. Finally, it makes shorter turns possible when discing small fields, gardens and truck patches.

Straightening Gangs Protects Grassed Waterways

Good soil conservation practice often calls for maintaining heavily sodded, grassed waterways in order to prevent gully-ing. But these grassed waterways are difficult to maintain when they are repeatedly crossed by a disc with the angle in.

With the Ferguson System, however, it is easy to take out the angle with finger tip control when about to cross a grassed waterway, and then to restore it on the other side—all, of course, without stopping.

Protection Against Miring in Soft Spots

Another valuable use for finger tip control is in overcoming the danger of bogging down in soft spots. When approaching such places, the disc gangs can be straightened instantly, thus greatly reducing the load on the tractor. After the soft spot is passed the angle is just as easily and quickly restored.

No time is lost in stopping, dismounting and mounting again, before and after crossing the



Grassed waterways are protected by easy straightening of disc gangs.

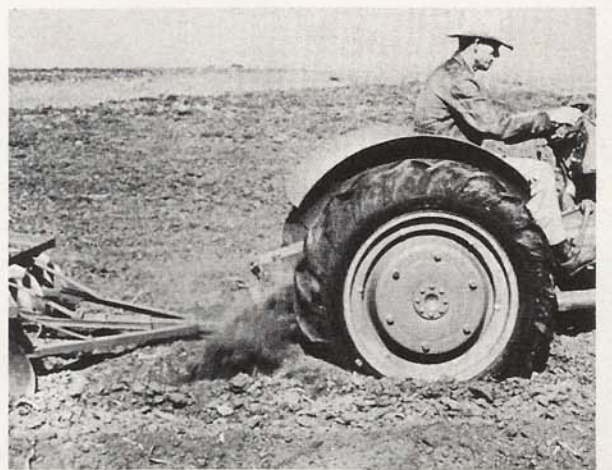

Tractor and disc are mired in a soft spot. It's easy to get out.



When mired in a soft spot, operator straightens disc gangs with finger tip control, reducing load, and goes on.

soft spot—perhaps many times during the rounds of the field—in order to make the necessary angle adjustments. This is also a great work-saver for a young or aged person.

Discing Suggestions

1. When discing plowed sod, the *first time over*, set the front gangs at a slight angle and weigh them down. This will make the discs cut through the plowed sod, instead of merely turning it back over, as may happen if the gangs are given maximum angle. The suggested angle setting applies to the rear gang, also. For additional discing after the first

time over, the angle, of course, should be increased.

2. The position of the scrapers in relation to the disc blades can be altered, as desired, through a convenient three-way adjustment. Normally, each scraper is set as close as possible to the disc blade without touching it, and slightly in from the blade's edge. Running the scrapers in contact with the discs, of course, tends to increase draft and wear.
3. When storing the disc, grease the disc blades and rest them on boards to prevent contact with damp earth.
4. Remove the bearing caps and examine the wooden bearings once each season. Replace any worn bearings, thereby reducing draft,

strain on the tractor, and fuel consumption.

5. It is desirable to use a new tractor on lighter work for a few days before putting it to a discing job. If this is impossible, set the disc gangs to keep the draft as light as possible until the tractor is broken in.

Cultivating Made Easy with the Ferguson System

First of all, the Ferguson Cultivator can be attached *in one minute*.

Consequently, while many a farmer is still trying to attach his cultivator, the Ferguson owner may come back from covering

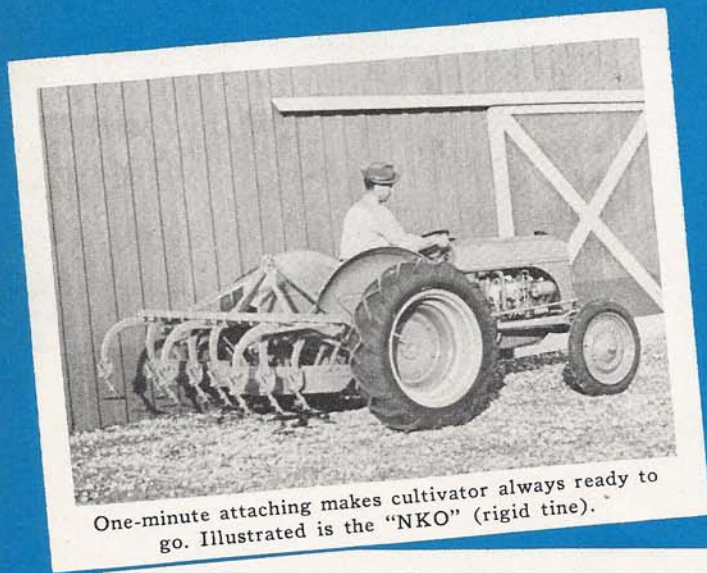

One-minute attaching makes cultivator always ready to go. Illustrated is the "NKO" (rigid tine).



In ground full of obstructions the "SKO" (spring tine) cultivator gives best results.



For listed crops, the "LKO" listed crop cultivator fills cultivating requirements ideally.

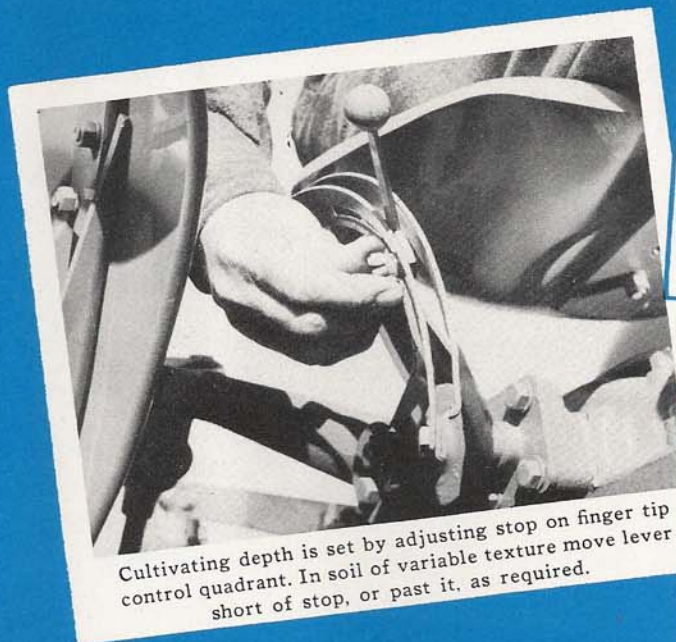

Cultivating depth is set by adjusting stop on finger tip control quadrant. In soil of variable texture move lever short of stop, or past it, as required.



Keep steering guide over crop row. No need to look back at cultivator.

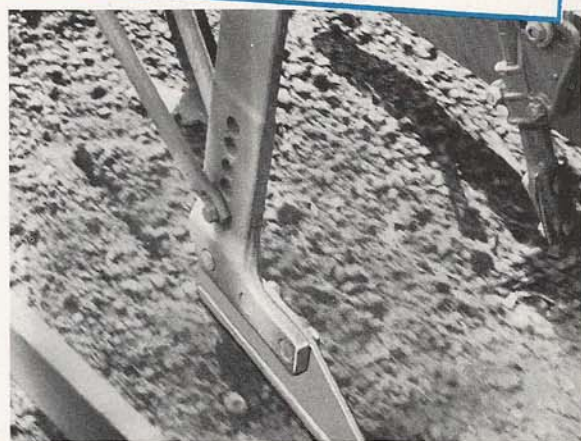

Fin acts to make cultivator follow front end steering. Should be set about 2" lower than shovels.

several acres, ready to take off his cultivator and do something else.

A Ferguson Cultivator, either the "NKO" (rigid tine) or "SKO" (spring tine) is a marvel of simplicity. It has very few parts, and no levers or coil springs. It mounts without using a single bolt, nut or cotter; in fact, without the use of a tool of any kind. Attachment is by the Ferguson System three-point method (described under "Tractor Operation," page 15).

There is great flexibility of adjustment of the tines. And because of the cultivator's position

on the rear of the tractor, no trace of a wheel track is left in the cultivated field.

Setting the Steering Guide

Upon reaching the field and entering the first rows, center the tractor exactly over the rows to be cultivated. The operator then fastens the steering guide to the right front axle, directly over the crop row and pointing in line with the row. While cultivating, the operator steers simply by watching the steering guide and keeping it in line with the crop row.

Quadrant Stop Marks Depth

As soon as you have determined how deep you want to cultivate, fasten the quadrant stop in place with the wing nut. This will stop the finger tip control lever at the same spot each time you lower the cultivator. Yet it is easy to set the lever either below the stop or short of it, if necessary to offset soil changes in the field, thus maintaining uniform depth.

Purpose and Adjustment of the Fin

The flexible connection of the Ferguson System linkage

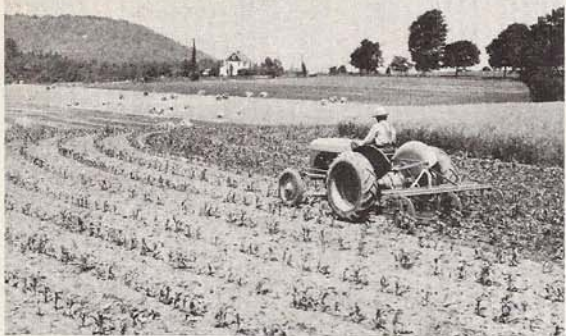

Relaxed, straight-ahead steering makes rear-mounted cultivator easy to use on straight or contour rows.



Tines may be spaced as desired for rows of various widths.



Fenders may be set to allow some dirt to sift under to cover small weeds without covering young plants.

gives the cultivator a certain desirable amount of "play" from side to side. It is this method of mounting, plus the action of the "fin" that, for the first time, enables perfect cultivating with an implement which is mounted entirely on the rear of the tractor.

The fin, under average conditions, should be set to work approximately two inches below the level of the shovels or sweeps. It causes the cultivator to move in the direction in which the tractor is steered. It also helps to hold the cultivator and tractor in line when working along hill-sides. For land covered with

trash or vines, a rolling fin is available.

Purpose and Adjustment of the Fenders

The fenders are of the flexible type and have a large variety of possible adjustments, up and down, sidewise, and backward and forward.

All adjustments can be made with no more tools than the one wrench that comes with the Ford Tractor Ferguson System, and the fenders can be raised or lowered without the use of tools. They may be adjusted to travel parallel to the ground or with

forward or rear ends raised as desired.

Under usual conditions, the fenders should ride just high enough above the ground to let some dirt sift under them and cover small weeds, but not enough to cover the crop plants. When the plants are advanced in growth, the fenders may be removed for the remaining cultivations.

Spacing the Tines

Holes at 1" intervals throughout the length of the sturdy, heat-treated frame members provide accurate lateral spacing of the

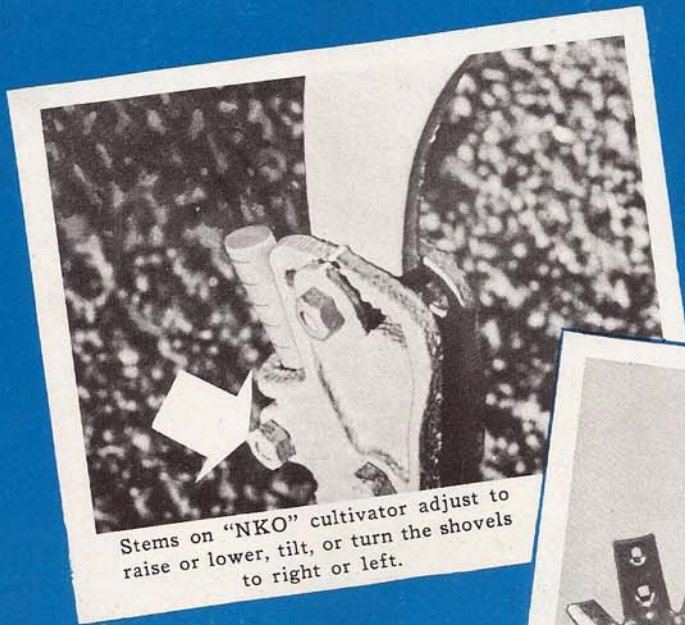

Stems on "NKO" cultivator adjust to raise or lower, tilt, or turn the shovels to right or left.

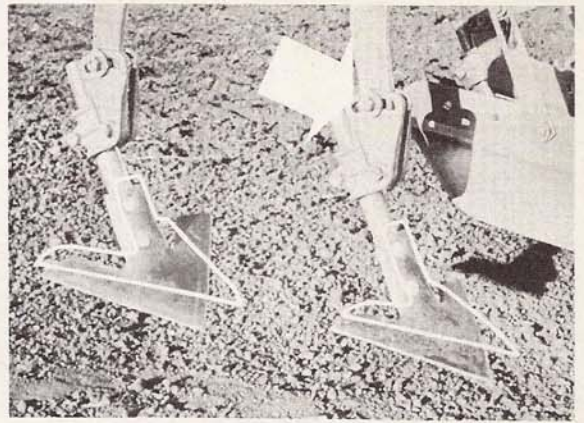

Pitch of sweeps or shovels can be adjusted as desired.

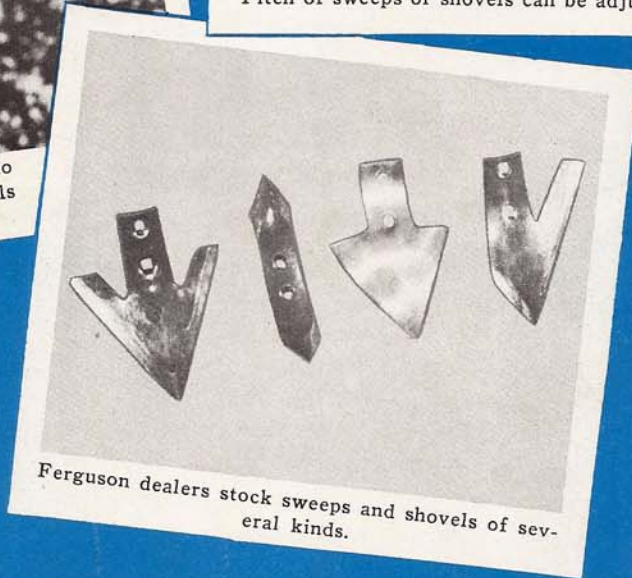

Ferguson dealers stock sweeps and shovels of several kinds.

tines, for working close to the rows and for rows of different widths. By interchanging the tines from one position to another, a great variety of combinations is possible for cultivating rows of various widths.

3-Way Shovel Adjustment

These adjustments make it possible to fit the shovels, or sweeps, to the contour of the crop rows, whether the crops are planted level, on beds or in listed furrows.

Stems may be raised or lowered through an effective range of 6 inches. The stem may also

be rotated, thus turning the shovel toward, or away from, the plants. Finally, the angle of the tine foot may be changed to give a flat or sharp pitch to the shovel.

Markings on the stems and foot castings make uniform adjusting easy; and all adjustments are made with only one wrench.

Leveling the Cultivator

Ordinarily, the cultivator should run level, and this is easily assured by adjusting with the leveling crank on the tractor. By use of the leveling crank, the operator can raise or lower either

end of the cultivator as desired, in order to maintain uniform depth when working along back furrows, dead furrows, contour or terrace ridges, or under other similar conditions.

A Ferguson Invention— the Tiller

The Ferguson Tiller is a new implement made possible by the Ferguson System.

The great advantage of the tiller is the wide variety of jobs it can do well. It does them principally through its ability to work at a considerable depth



The tiller has many uses. Shown here preparing seedbed for fall planting.



The tiller works deep when desired. Maximum depth is 9".



Tines may be spaced by 1" intervals to suit different requirements.

when required, and yet to do a fine job right on the surface, too.

Easy to Use

Anyone, old or young, can operate the Ferguson Tiller. It attaches by the usual Ferguson System 3-point method (described on page 15) and it is raised, lowered or set for depth by finger tip control. It is adjustable for tilt by the leveling crank on the tractor. And the position of the tines can be changed at will, simply by selecting different bolt holes that run the whole length of the frame at 1" intervals.

Aside from keeping the bolts tight and the points in good condition, it can truthfully be said that there is nothing to know about the operation of the tiller. All you need do is put it on and go, setting the working depth to suit the job, right from the tractor seat without stopping, by moving the finger tip control lever up or down.

Tines Automatically Reset After Striking Obstructions

One thing that makes the tiller so usable for so many operations is the coil spring mechanism that takes the shock off the

points and tines.

If a point hits a tough obstruction, such as a firmly anchored rock, the tine merely snaps backward and upward to clear the rock. Then it snaps into place again, and the point goes right on working without stopping the tractor. There is no damage done, no time lost, no unworked land left. Only the tine that strikes the obstruction is raised, and that without any attention or worry by the operator.

Prepares Seedbeds Without Plowing

There are many times when a

farm operator would like to prepare a seedbed without plowing. Under many conditions of soil, crops, or climate, it often is practical to prepare satisfactory seedbeds in less time, at less cost, with the versatile Ferguson Tiller.

The tiller is especially valuable, in addition, for cultivating land filled with rock or root obstructions, as protection is afforded and time saved by the automatic tripping and resetting of the spring-controlled tines.

Many Uses On Every Farm

Besides seedbed preparation, the tiller is widely used as a field cultivator to control various types of noxious weeds; for orchard and vineyard cultivation; pasture renovation; fallowing of stubble; and for tillage operations formerly done by other means.

The varied usefulness of the tiller is made possible by the many kinds of points available for it—including double-pointed shovels, quack grass points, chisel teeth, alfalfa teeth and duck-foot shovels.

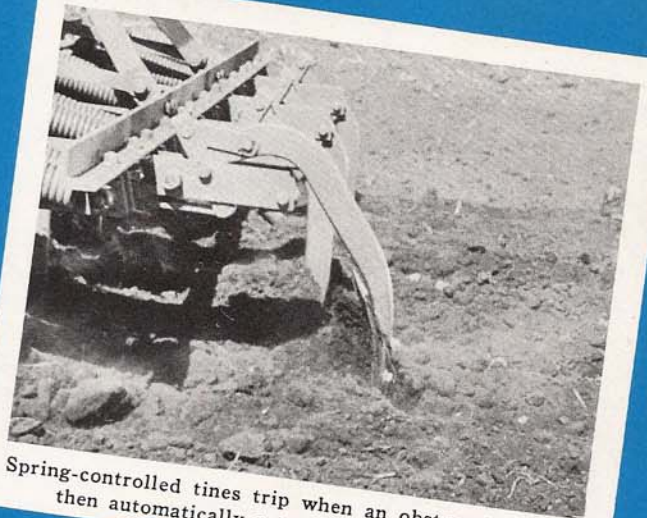

Spring-controlled tines trip when an obstruction is hit, then automatically return to working position.



Tiller can be tilted with leveling crank when working in orchards close to trees.

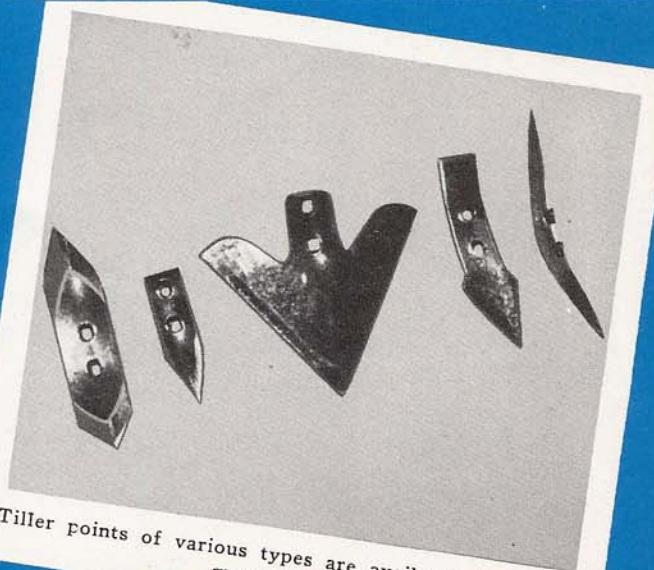

Tiller points of various types are available from Ferguson dealers.

*How to get
the "Pluses"*

CARE OF YOUR FORD TRACTOR FERGUSON SYSTEM

Uses Natural Forces

It was Harry Ferguson's idea to develop a system that would use natural forces to the utmost—and mechanical parts as little as possible.

We have seen how, as a result, the Ford Tractor Ferguson System was made so easy to operate that young or aged people are as much at home on it as is a man in his prime.

Now, this simplicity of construction brings about another important benefit, too: The care of the tractor is reduced to a minimum.

In fact, it is safe to say that, even if the owner did nothing but keep the tractor lubricated, the radiator full of water, air in the tires, the air cleaner properly serviced, oil filter changed and oil filler cap cleaned, this tractor would go on for a long, long time, giving an excellent performance.

But, we are going to assume that you are the kind of owner who takes real pride in his farm equipment. If you are, then you will want to get the "pluses", or extras, that are obtainable from this rugged, modern-designed

tractor. You will want, not simply good performance, but the very finest performance possible, at all times.

You will recognize that this is good business, too, because it saves time and money in the end. If you can reduce farming delays caused by repairs, and make your tractor last years longer, too, then a little attention to proper care is just like putting money into the bank.

The information that you will read here on tractor care may cover things that you would do anyhow. But it will be a good



The Ford Tractor Ferguson System is as easy to care for as it is to operate, by young or old.



A little extra care is like putting money in the bank.



Four Lubrication Rules: (1) Keep nine fittings lubricated with grease gun.

idea to review them and to examine the reasons behind them.

We will confine this information to things that you can do yourself. Naturally, any major repairs or adjustments or overhaul jobs should be left to your Ferguson dealer. He has the proper tools and equipment for such work, and his mechanics are trained in the Ferguson school. In the end, you will save money by using your Ferguson dealer in this way, keeping your own time free for farming.

Correct Lubrication

The main purpose of lubrication, of course, is to keep a thin layer of oil or grease between the moving parts, thereby reducing friction, heat and wear and also to produce a sealing effect between piston and cylinder wall.

An important, secondary purpose is to keep the parts clean—by forcing old dirty grease out of the bearings and by draining dirty oil out of the crankcase. A third function is to assist in cooling moving parts.

The lubrication system of the tractor is designed for highest efficiency and also for the greatest convenience to the owner.

To lubricate every moving part it is only necessary to grease nine fittings, supply oil to the engine and transmission, pack the front hubs with grease once a season and oil the generator twice a season.

Changing the Engine Oil

When breaking in a new tractor, the oil should be changed after the first 30 hours of operation. The reason is that fine metal particles from new bearing surfaces may collect in the oil and it is desirable to dispose of these

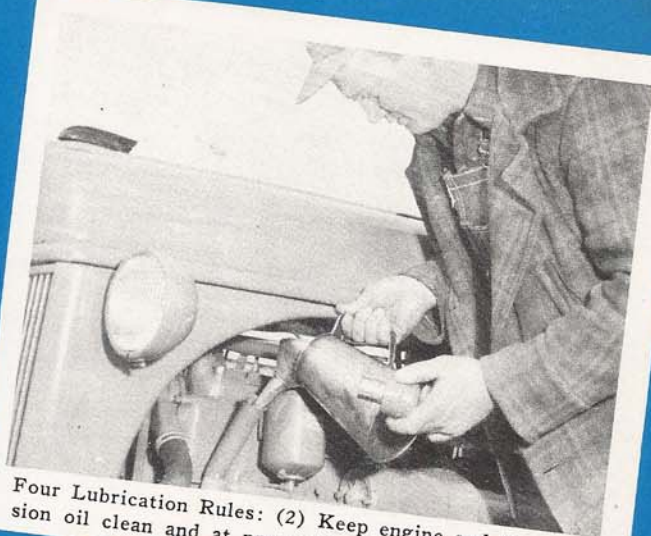

Four Lubrication Rules: (2) Keep engine and transmission oil clean and at proper level. Use correct grades.



Four Lubrication Rules: (3) Repack front wheels with short fiber grease once each season.

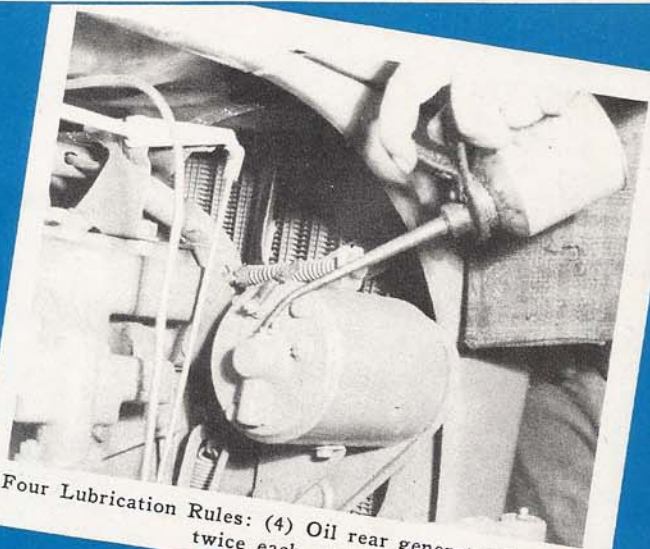

Four Lubrication Rules: (4) Oil rear generator bearing twice each season.

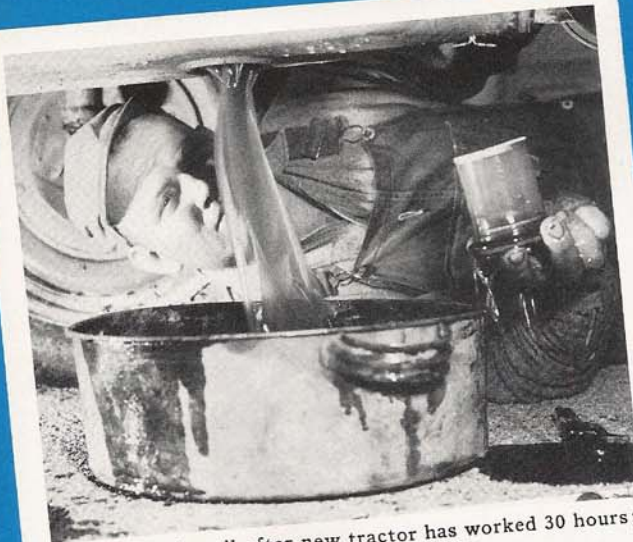

Change engine oil after new tractor has worked 30 hours; thereafter, each 200 hours.



Clean oil pump screen (on drain plug) in gasoline at each oil change. Replace carefully.



At each oil change, discard oil filter cartridge, clean the oil filter and insert new cartridge.

by draining off the oil. Thereafter, the oil should be changed every 200 working hours, or oftener, if it shows dark on the oil dip stick. Running the engine for a short time will warm the oil and make it drain out better.

The oil pump screen comes out with the oil pan drain plug and is made this way so that the operator will be reminded to clean the screen each time he changes the oil. This is easily done simply by dipping it in gasoline. When replacing the oil pan plug use care against possible damage to the screen.

With every change of oil, a new Trac-Pak cartridge should be put into the oil filter. Get these from your Ferguson dealer and keep them on hand. This is sound economy as the cartridge filters out dirt or grit that otherwise would remain in the oil. Thus, it keeps the oil from carrying these foreign particles to the moving parts where they would increase wear and shorten the life of the engine.

The oil capacity of the crankcase is six quarts.

The proper viscosity (heaviness) of oil to use depends on the temperature of the atmosphere and ranges from S.A.E. 10W to 30 for various seasons and climates. Reference to the tractor lubrication chart in this book will determine the correct S.A.E. number for each temperature range, and this should be followed carefully.

If too light an oil is used in hot weather, a sufficient oil film will not be maintained between the moving parts.

And if too heavy an oil is used in cold weather, it will not flow between the bearing surfaces properly, as these are machined to very close tolerances.

Thus, in either of the above cases, many parts are deprived

of the protection that good lubrication gives, and, therefore, are damaged by undue friction and heat.

To buy "cheap" lubricants is false economy and cannot be recommended. They frequently cause heating, oxydizing and the formation of sulphur or tar residues. Therefore, binding or undue friction may result, which will increase wear and fuel consumption and shorten the life of the moving parts.

After changing the oil, idle the engine for a short time in order to coat the moving surfaces with

the new oil.

The level of the oil in the crankcase should be kept within the working range as shown on the dip stick and should be checked every day before putting the tractor to work.

Changing the Transmission— Hydraulic—Differential Oil

The transmission, differential and the hydraulic pump all are lubricated with the same oil which is put in through a single opening in the top of the transmission housing. Use five gallons of a straight mineral oil, S.A.E.

90 for temperatures above freezing and S.A.E. 80 for temperatures below freezing. (See Lubrication Chart, page 59.) Since the use of the proper oil is of the greatest importance, you should consult your Ferguson dealer and follow his recommendations.

This oil should be changed, if the tractor is new, after the first 200 working hours, and thereafter once every 600 working hours. It is drained from three openings, one in the under side of the transmission housing and two in the bottom of the differential housing.



Keep a carton of Trac-Pak cartridges on hand. Use a new one at each oil change.



First-quality lubricants, of correct S.A.E. number, are cheapest in the end.



The same lubricant is used in transmission, differential and hydraulic. Change after first 200 working hours; thereafter, each 600 hours.



Underview, showing transmission-differential-hydraulic oil drain plugs; also engine oil drain plug.

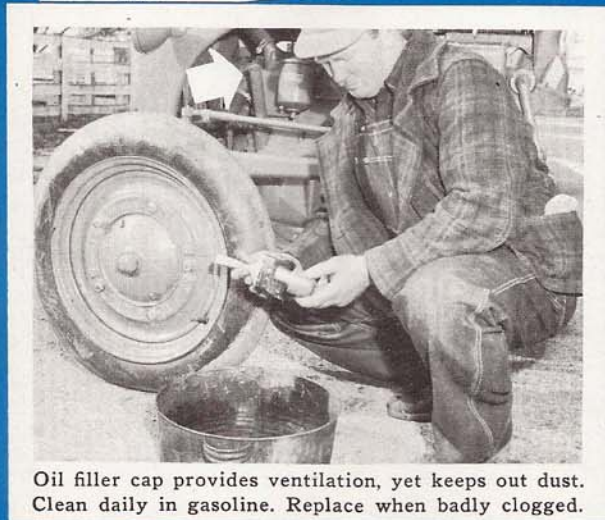

Oil filler cap provides ventilation, yet keeps out dust. Clean daily in gasoline. Replace when badly clogged.

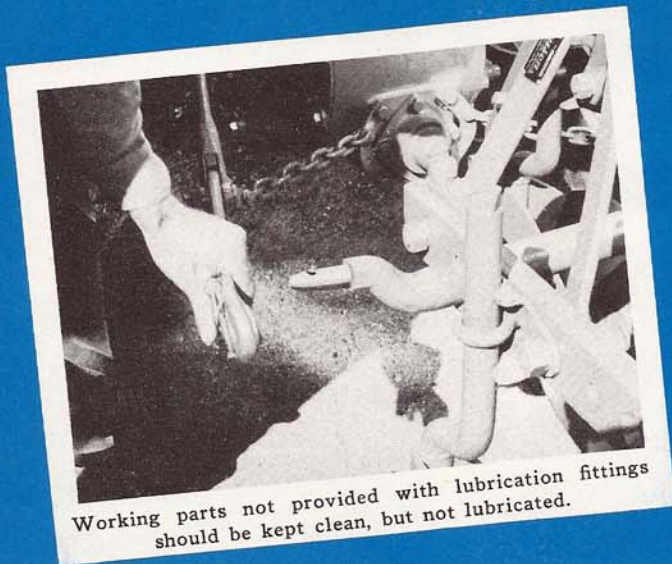

Working parts not provided with lubrication fittings should be kept clean, but not lubricated.

In the more northern climates it is especially important to change to lighter grade oil before cold weather sets in. Otherwise, unsatisfactory, sluggish performance will result, and fuel consumption will be high.

Use of improper grade of oil will cause undue wear on gears and all other moving parts of the transmission, differential and hydraulic pump. The control valve is also liable to stick, due to the formation of a varnish-like deposit.

Cleaning the Oil Filler Cap

It is important to inspect daily the oil filler cap and to wash it in gasoline when dirty. (Note: Avoid putting hands in leaded gasoline. To do so may cause severe skin irritation. Do not use gasoline indoors.) If the cap becomes clogged, there is no escape for the moisture formed by condensation in the crankcase, and sludge is formed. In addition, pressure builds up in the crankcase, forcing oil out through the rear main bearing. When an oil filler cap can no longer be cleaned properly, it should be replaced with a new one.

Lubricate Only Where Fittings Are Provided

This is actually a case where too much care is worse than none. Oiling the ball joints of the linkage, for example, merely encourages the collection of dust which causes wear. Keeping these parts clean and bright is all the attention that they require. Do not lubricate any part that is not provided with an opening or fitting to receive oil or grease (except for packing the front wheel bearings with short fiber grease once a season).

In general, when using the grease gun, force in enough new grease to push the old, dirty grease out of the bearing. An exception should be made, how-

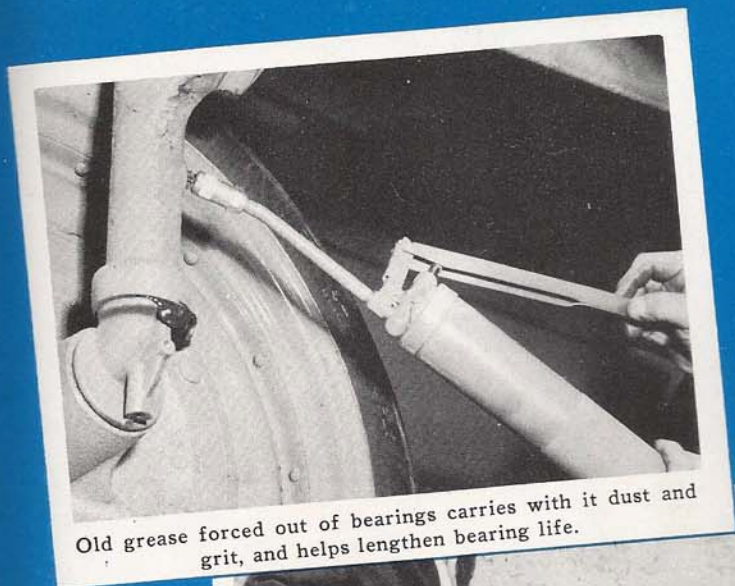

Old grease forced out of bearings carries with it dust and grit, and helps lengthen bearing life.

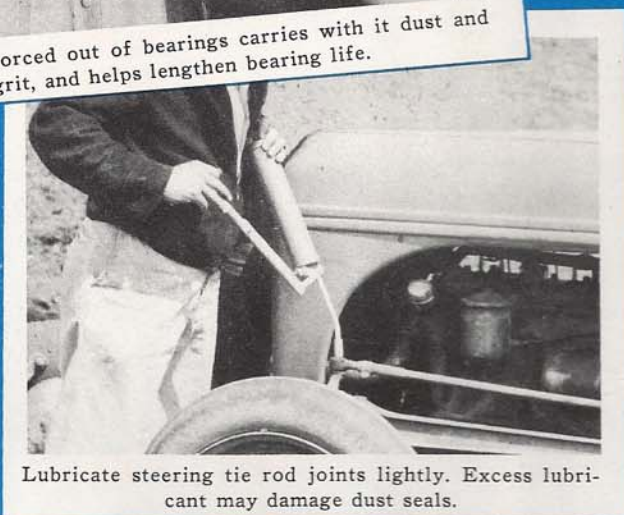

Lubricate steering tie rod joints lightly. Excess lubricant may damage dust seals.



Diagram of air cleaner, showing how air is cleaned by a series of screens and oil bath.

ever, in the case of the zerk fitting on the steering post. Only a small amount of lubricant should be used at a time, to prevent grease running down into the transmission oil.

As a protection against dirt, zerk fittings should be wiped clean before and after lubrication.

Care of the Fuel System

The fuel system includes everything needed to bring fuel into the engine manifold. It consists of the fuel tank, fuel filter, air cleaner, carburetor and the fuel line.

Every part of this fuel system is as nearly perfect as engineering genius can make it. For example, the carburetor is designed so that air can enter only through the air cleaner, an extra precaution against the entry of dirt. Your engine always receives maximum protection from dirt and dust if the cleaner is given proper care. Naturally this effective straining out of dirt means less wear on pistons and cylinders, as well as smoother, steadier performance at all times.

While this excellent fuel system requires a minimum of attention, it is just good sense to

do the few things required for best performance.

Care of the Air Cleaner

Because the care of the air cleaner (located under the right side of the hood) is so important, it is well to understand how it works.

While the engine is running, a suction is formed that draws air in through the pre-cleaner, or top screen, of the air cleaner. This is the first step in cleaning the air that forms 90% of the fuel mixture. The pre-cleaner is especially designed to keep out the "big" dirt, such as leaves and chaff.

Next, the air is drawn down through the central tube of the air cleaner, and after being partly cleaned in the oil bowl, comes up around this central tube. This outer space is filled with a series of screens that filter out the very finest particles of dust.

One other thing is required, however—the constant bathing of these screens with oil in order to trap the dirt most effectively. This is a second duty of the oil bowl which is assembled to the bottom of the air cleaner and filled with oil. The constant splashing of the oil against the screens above it washes the dirt

down, as fast as it collects, into the oil cup where it settles to the bottom.

The thoroughly cleaned air finally passes through the air cleaner outlet, and hose, to the carburetor.

It is clear from the operation of the air cleaner, as described, that there are but two places where care is required. The top screen, or pre-cleaner, needs to be cleaned daily (washed in gasoline and thoroughly dried before replacing). Oil should be kept off this part, as it would cause more dust and dirt to collect, clogging the openings.

The oil cup should be removed daily, emptied, wiped clean and refilled to the level marked, with the same kind of oil as used in the engine.

Do not fill the oil cup higher than the bead which marks the proper level. Additional oil would not help and might even be harmful to the most efficient operation of the air cleaner.

The oil cup should never be removed while the engine is running, as dirty air would be admitted into the fuel system.

The screen filtering element should be removed occasionally and given a thorough cleaning



Wash air cleaner top screen daily in gasoline. Dry thoroughly. Keep free of oil.

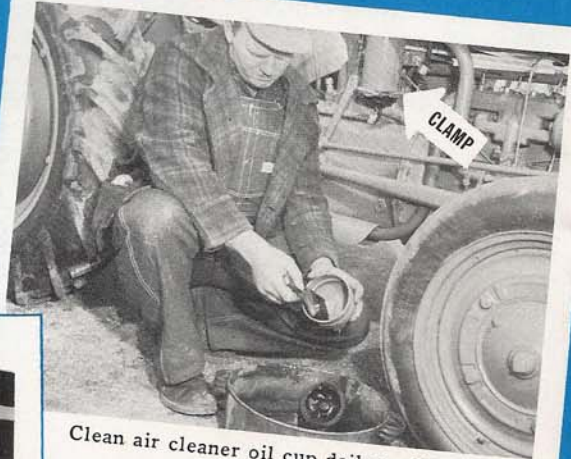

Clean air cleaner oil cup daily; refill with clean engine oil.



Showing the three parts of the oil cup assembly.

with gasoline to remove any dirt that may have been deposited by the oil.

Watch for any air leaks in the rubber hose from air cleaner to carburetor. The hose should be checked every 60 working hours and replaced at the first sign of a leak.

Protection Against Extreme Dust

Two things should be done when using the tractor under unusually dusty working conditions. First, the cleaning of the air cleaner (explained above) should be done several times a day instead of only once a day. Second, the air cleaner should be fitted with an extension which is made for the purpose and can be obtained from your Ferguson dealer. The function of the air cleaner extension, of course, is to draw in air at considerably higher than the usual level, well above the worst of the dust.

Cleaning the Fuel Filter and Sediment Bulb

Just as the air cleaner stands guard against dirt in the air supply, so the fuel filter and sediment bulb protect against dirt and water in the fuel supply.

On the side of the assembly that contains the fuel filter and sediment bulb is a valve that controls the flow of gasoline through the fuel system. The valve is plainly marked to show its position for the main supply, the reserve, or off. Should the fuel in the main supply become exhausted, turning the valve to the "Reserve" position will release the gasoline from the reserve supply (about one gallon capacity). The valve should be turned to the "Reserve" position occasionally for about 15 minutes, while the tractor is operating. This will prevent plugging of the reserve fuel opening.

The sediment bulb should be



When dust flies, air cleaner should be cleaned several times a day.

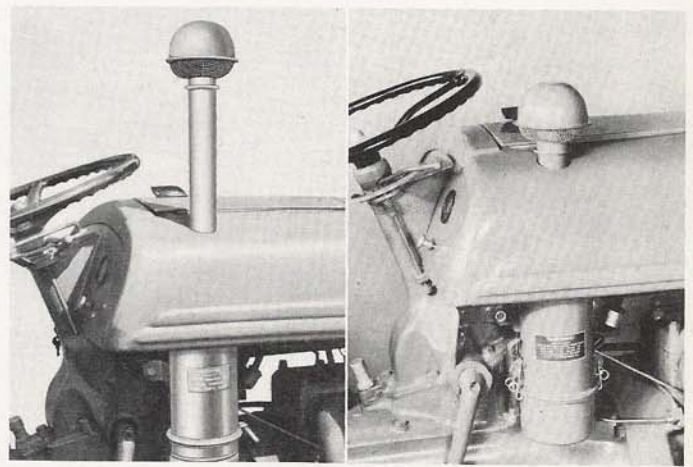

When working in unusually heavy dust, air cleaner should be fitted with extension. Cut 9 $\frac{3}{8}$ " from extension for orchard work.



Keep air cleaner hose connections tight and in good condition.



Fuel valve regulates flow from main and reserve supplies.

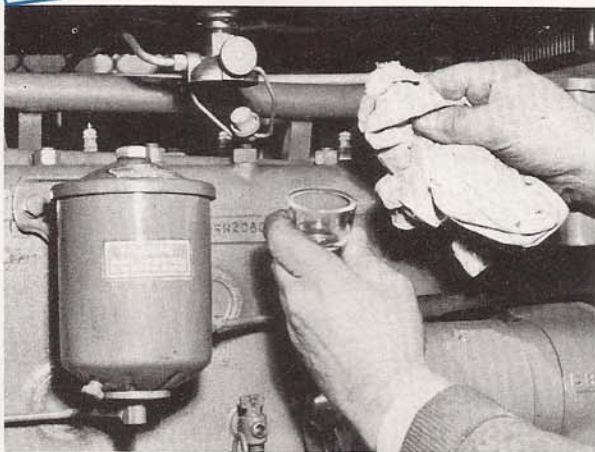

Sediment bulb and screen should be removed and cleaned occasionally.

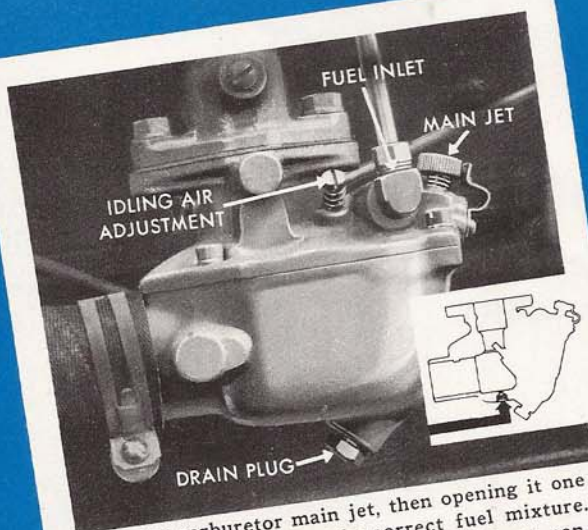

Closing carburetor main jet, then opening it one turn, gives approximately correct fuel mixture. (Inset) Arrow shows drain which allows condensation and excess fuel to escape. Do not remove drain filter packing.

inspected frequently and, if dirt or water has settled in it, the bulb should be removed (by loosening sediment bulb clamp), emptied, wiped clean and replaced. Neglecting this precaution habitually will permit some of the dirt or water to be carried into the fuel line and other parts of the system, and may cause fouling, uncertain performance or complete stoppage.

Occasionally the fuel filter may need to be cleaned. The fuel filter is a fine wire screen disc located above the sediment bulb and removable with it. When re-assembling, see that the gasket is replaced between the fuel filter and the sediment bulb and that there is no leakage.

Care of the Carburetor

The main jet is adjusted by turning the flat, knurled knob located toward the front on the upper half of the carburetor. The approximate correct adjustment is made by closing this valve and then opening it one turn. Too lean a mixture should not be used, as this may overheat the motor.

The idling air adjustment is located about midway of the top part of the carburetor and is provided with a slot for a screw driver. It should be turned in or out until the motor idles smoothly, after the engine is warmed up.

About every 60 working hours, drain the carburetor and fuel line by removing the drain plug on the bottom of the carburetor—in order to remove any dirt or gum that may have collected. (The main fuel valve, located above the sediment bulb, should be closed while doing this.)

In the fuel inlet connection of the carburetor is an elbow strainer which should be cleaned occasionally. This can be done without removing the carburetor by disconnecting the gas line.

At the bottom of the carburetor is a small opening packed with felt (see picture bottom of page 48). This opening allows condensation or excess fuel (due to over-choking) to escape. The felt packing should never be removed, as it prevents dust from being drawn directly into the carburetor.

Draining Entire Fuel System

If the tractor is not to be used for thirty days or more, the entire fuel system, including the tank, should be drained. This is because gum that may clog the carburetor may form in stored gasoline. The fuel should be removed through the carburetor drain and the sediment bulb valve should be set on "Reserve".

It is a good idea to keep spare fuel filter screens and sediment bulbs on hand in case of loss or damage.

Care of the Cooling System

The tractor cooling system is simple throughout and remarkably efficient. It makes possible, for the first time, a tractor engine that runs at approximately the same temperature as an automobile engine.

In fact, while many types of anti-freeze, when used in the ordinary tractor, will boil out, this tractor engine runs so cool that they can be used satisfactorily in all usual winter operations. One reason for this greater efficiency is the engine water jackets that extend down clear to the level of the bottoms of the cylinders.

The Radiator

The cooling system requires very little attention. The principal thing is to use clean water in the radiator at all times and check the water level before leaving for the field or otherwise using the tractor. In the winter an anti-freeze should be used, or

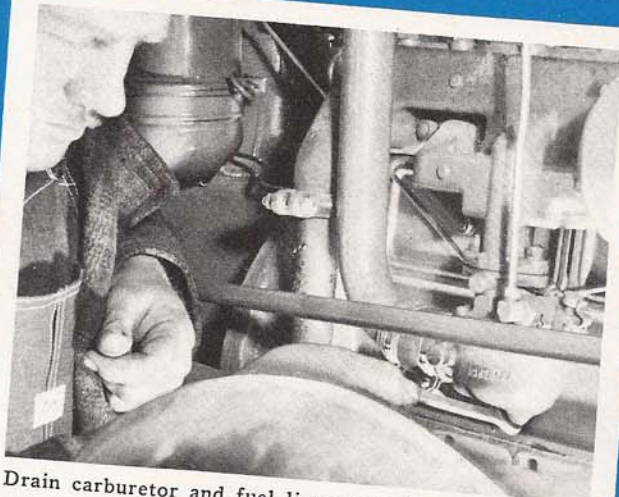

Drain carburetor and fuel line every 60 working hours. Close main fuel valve.

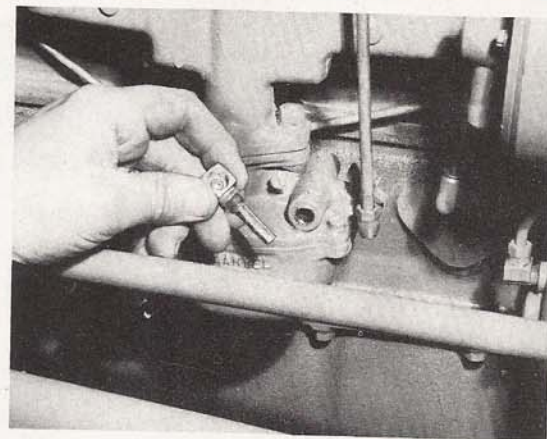

Occasionally, disconnect fuel line, remove and clean carburetor elbow strainer.

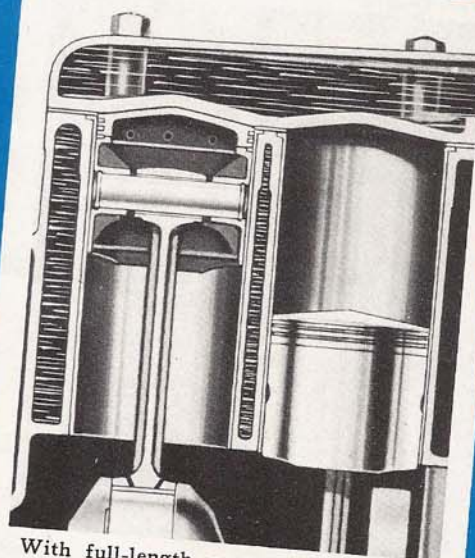

With full-length water jackets around engine cylinders, the tractor runs cool. Investigate any overheating.

great care taken to drain the radiator immediately after each use of the tractor. Otherwise, freezing and damage to the radiator, or even to the engine block may occur. A rust inhibitor is recommended, in case the water used causes rust.

The cooling system is drained by opening the pet cocks, one at the bottom of the radiator core, and the other on the left side of the engine block. Both must be opened, and should be left open, when draining the system to prevent freezing. The capacity of the cooling system is 12 quarts (14 quarts in tractors not having pressure cap).

When draining the radiator, if equipped with pressure cap, loosen the cap to insure complete drainage. Use care in removing the cap, if the engine should be overheated, in order to prevent injury by steam or scalding water.

Radiator Hose Connections

Examine all hose connections frequently and tighten, or replace hose as needed. When replacing the top hose connection do not overlook the thermostat which is placed inside this hose. This thermostat is designed to keep the water inside the engine jacket at 165° (at which point

it opens to admit cold water from the radiator).

The fan belt should be kept adjusted tightly enough to prevent slippage, which would cause undue belt wear and eventually would impair the efficiency of the cooling system. The tension can be checked by pushing the belt inward at a point midway between the generator and crankshaft pulleys. If it can be pushed more than one inch out of line at this point, the belt is too loose and should be tightened. This is done by turning the bolt in the spring which puts tension on the generator. The bolt should be turned in a coun-



Radiator water must be clean. If it causes rust, add a rust inhibitor.



Draining radiator. Small view: Looking up under radiator at pet cock.

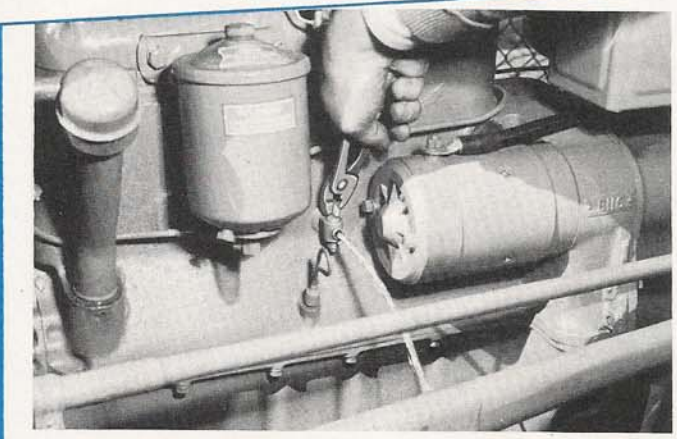

Unless anti-freeze is used, engine block, as well as radiator, must be drained after use in freezing weather.

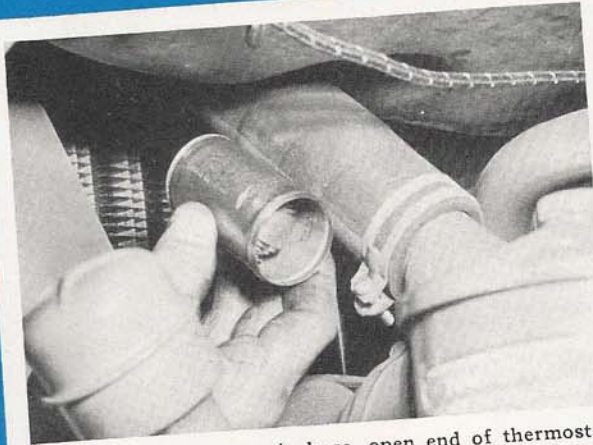

Location of thermostat in hose, open end of thermostat toward engine.

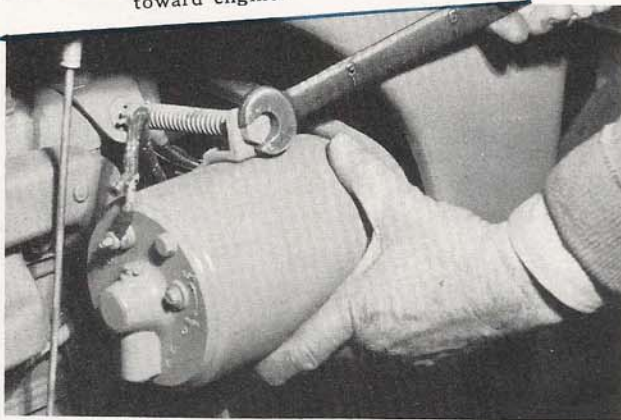

Fan belt tension is adjusted by turning bolt in spring on the generator. A belt tightener assembly is available for installation on older tractors.

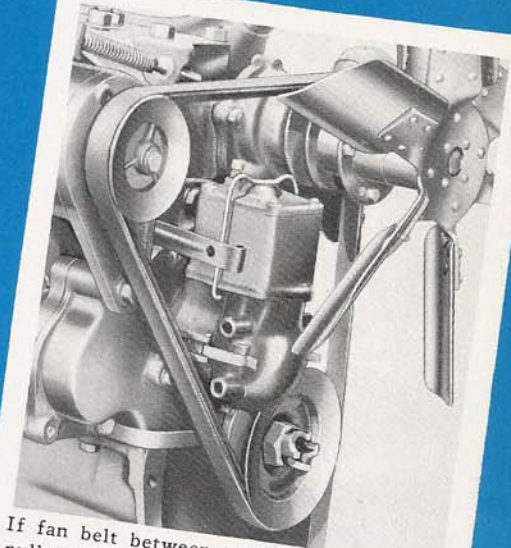

If fan belt between engine and generator pulleys can be pushed more than 1" out of line, it should be tightened.

terclockwise direction.

Trash collecting on the radiator and between the radiator cores will reduce the efficiency and should be cleaned out with compressed air, water pressure or similar means, when necessary.

It is well to keep spare hose connections and fan belt on hand, as a protection against delays during rush work.

Care of the Electrical System

The principal purpose of the electrical (or ignition) system is to provide sparks that will ignite the fuel in the combustion

chamber. It does this by stepping up the low-voltage battery current, by means of a coil, to a high-voltage current, then, through a distributor, feeding this current to the spark plugs one by one. The high voltage enables the current to jump across the gap of the spark plug, and this produces the spark.

The electrical system has two other important duties, to supply current for the starting motor and for the lights.

As is true throughout the Ford Tractor Ferguson System, simple, rugged construction and ease of maintenance characterize

the electrical system. Very little care is required, but that little will pay for itself many times over in better performance and freedom from trouble.

The Generator

The charging rate of the generator is from 4 to 16 amperes and is indicated on the ammeter (located on the instrument panel). The charging rate of the generator is adjusted by means of the screw located at the rear of the generator. A directional arrow shows which way to turn the screw to increase or decrease the charging rate. Set the generator



Check battery every 30 working hours. Keep plates covered with distilled or clean rain water.

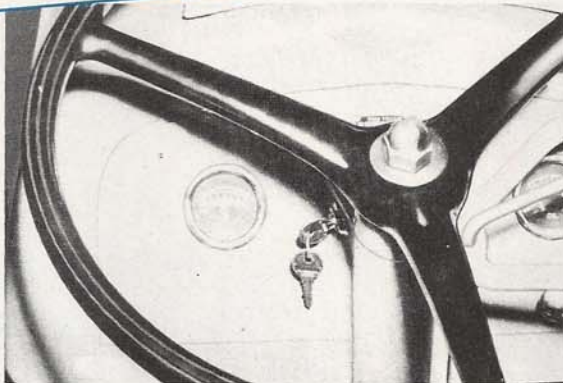

Ammeter on dash shows charging rate of generator.

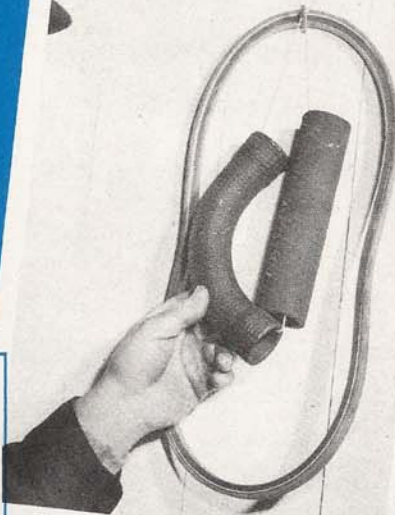

Keeping new hose connections and fan belt on hand may save delay in a busy season.

at the lowest charging rate that will keep the battery fully charged. Too high a charging rate will cause the battery solution to boil and will shorten the life of the battery.

Rear Generator Bearing

Once every 300 working hours, or not less than twice a year, the rear generator bearing should be lubricated with a few drops of engine oil.

Care of the Battery

The battery should be examined every 30 working hours, and distilled water added, if neces-

sary. Clean rain water caught in a wood, crockery or glass container may be used if distilled water is not available. The plates should always be well covered with water. Each cell should be filled until the water is level with the lead washer in the filler neck.

Caution: After filling battery, *always replace battery cover plate* to prevent gasoline from being spilled on battery or engine when filling fuel tank.

The terminals should be kept clean and greased to prevent corrosion, and connections kept tight. If the tractor is to be idle for 30 days or more, remove the

battery to a service station, or keep it charged by running the tractor occasionally. It is well to remember that a battery will not freeze if it is well charged but may freeze if the charge is low.

Care of Spark Plugs

The first point of care here is to have the right plug. Use the plug recommended by your Ferguson dealer.

The plugs should be well seated but not screwed in too tightly. They should be cleaned and the gaps reset about every 200 working hours and replaced with new ones every 500 working hours.



Keep battery terminals tight and greased to prevent corrosion.



After inspecting or filling battery, always replace battery cover plate.

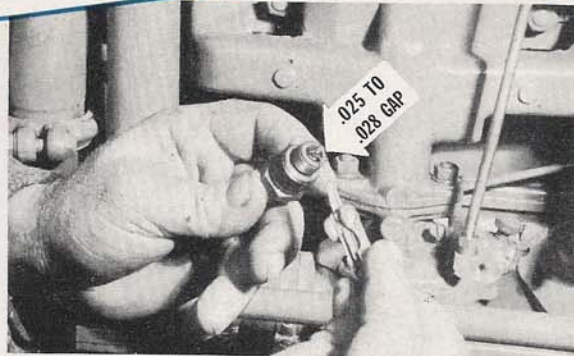

Feeler gauge checks spark plug gap. Ferguson dealers have special machines for cleaning and adjusting plugs.

The operator can clean his own plugs and reset the gaps, bending only the outside electrode and measuring the gap (.025" to .028") with a feeler gauge. However, the wisest practice is to have your Ferguson dealer sand-blast the plugs and reset the gaps. It is well to keep extra spark plugs, and battery filler caps on hand.

Care of Hydraulic Mechanism and Linkage

Although this is one of the most important "departments" of the tractor, Ferguson engineering has made it so nearly "fool-proof" that almost no care is required.

The ram cylinder bolts must be kept tight, but this is a matter of occasionally checking the four hex nuts under the seat spring.

It is important that all parts of the linkage move freely. This should be accomplished, not by oiling or greasing (which would only collect dirt) but by keeping the ball joints and connections wiped clean.

Before attaching the belt pulley it is necessary to detach the check chain anchors from the housing. It is important, when replacing them, to see that the short ends are up. Otherwise, the chains would be twisted and

shortened, and the lift arms could not be raised to full height.

Care of the Tires

The tires are made to the correct specifications for the weight and power of the tractor and are of the highest quality. Like the other parts of the tractor, they require little attention—but that little extra care will pay well.

First in importance is inflation which should be:

Front 26 lbs. Rear 12 lbs.

Under-inflation weakens the side walls and sooner or later causes breakage that cannot be satisfactorily repaired. Over-in-

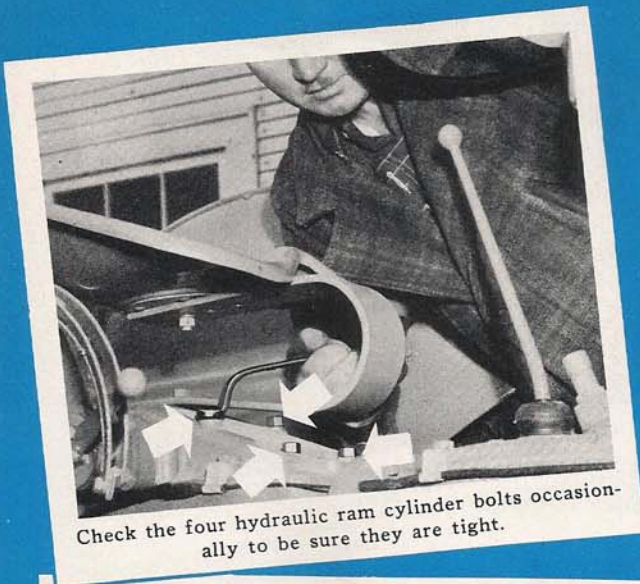

Check the four hydraulic ram cylinder bolts occasionally to be sure they are tight.



To keep linkage working smoothly, wipe ball joints and connections, but do not lubricate.



Inflate tires to correct pressures—rear 12 pounds; front 26 pounds. Check every 60 working hours.

flation, on the other hand, makes a hard ride for the operator, shortens the life of the tire, and causes excessive wheel slippage. So, it is well to keep to the recommended pressures, checking every 60 working hours. Your Ferguson dealer can supply a combination tire pump and gauge which operates from the tractor engine.

If you desire to use fluid in the tires, see your Ferguson dealer for anti-freeze formula and instructions.

Fruit or vegetable sprays, or other harmful chemicals, that may splash or settle on the tires should be washed off promptly to prevent damage to the rubber. Tires should be kept free of oil and grease (wipe with gasoline, if necessary).

Cracks in treads or side walls may admit enough dirt and moisture to rot the cord body of the tire. The proper treatment is to clean such injuries with gasoline and then fill them with tire putty which is made for the purpose.

Storing the Tractor

The Ford Tractor Ferguson System has so many valuable uses around the farm in winter that storing it is not common practice. Sawing wood, grinding feed, skidding logs, spreading manure—there's no end to the jobs the Ford Tractor Ferguson System can do to make farming easier and more profitable. But if you should have to store the tractor for some time, these are things to remember:

1. Jack and block the tractor up off the tires.
2. Wipe it clean.
3. In areas where winter temperatures go below freezing add sufficient anti-freeze to water in radiator to prevent freezing.
4. Remove the battery to a service station to keep up the charge and prevent freezing.
5. Drain and refill the crankcase with new oil and install new oil filter cartridge. Then idle the engine for a few minutes until vapors come out of the breather cap.

6. Remove spark plugs and squirt light oil into combustion chambers. Turn the engine over a few times to distribute the oil.
7. Drain fuel system and clean sediment bulb.
8. Remove valve cover and squirt light oil over valve stems, springs and push rods.
9. Lubricate all fittings to force out old grease.
10. Oil linkage ball sockets and pin connections to prevent rust.
11. Drain and refill transmission.
12. Keep tractor covered.

Putting the Tractor Back into Service

When ready to use the tractor again, here are the things to do before putting it back into service:

1. Replace battery.
2. Remove spark plugs and squirt two tablespoons of oil into each cylinder (to lubricate pistons). Turn engine over several times *before* replacing plugs.
3. Check water or anti-freeze in radiator.
4. Lubricate tractor thoroughly, forcing old grease out of bearings. Repack front wheels.
5. Fill fuel tank.
6. Check tires and inflate to recommended pressures.
7. Start and idle the engine for several minutes. Check oil pressure.
8. Check generator charging rate.
9. Check fan belt for correct tension.
10. Clean oil off linkage ball joints.
11. Check nuts and bolts for tightness.

Checking Bolts and Nuts

The Ford Tractor Ferguson System is extremely well built. Nevertheless, any machine that is subject to as much hard use as a farm tractor gets should be inspected occasionally for loose bolt and nut connections. Tightening these is especially simple on this tractor because they are so easy to reach.

Parts to Keep on Hand

It is not the cost of the part—it is the cost of the trip to town, and the cost of the job left undone that matter.

Therefore, the farm operator who wants to keep his work mov-

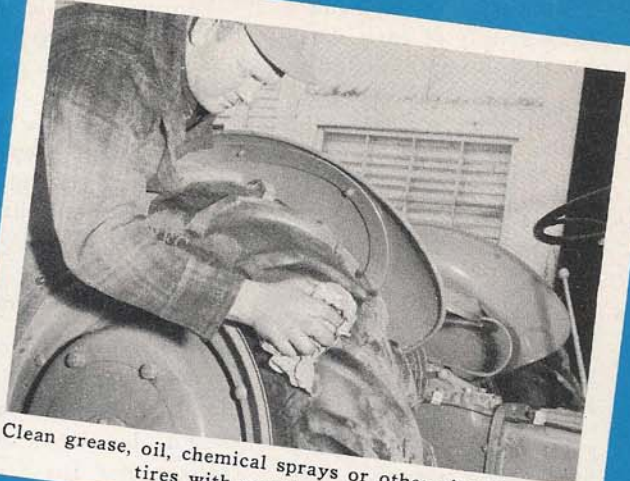

Clean grease, oil, chemical sprays or other chemicals off tires with gasoline promptly.



Clean cracks in tires with gasoline and fill with gum rubber made for the purpose.

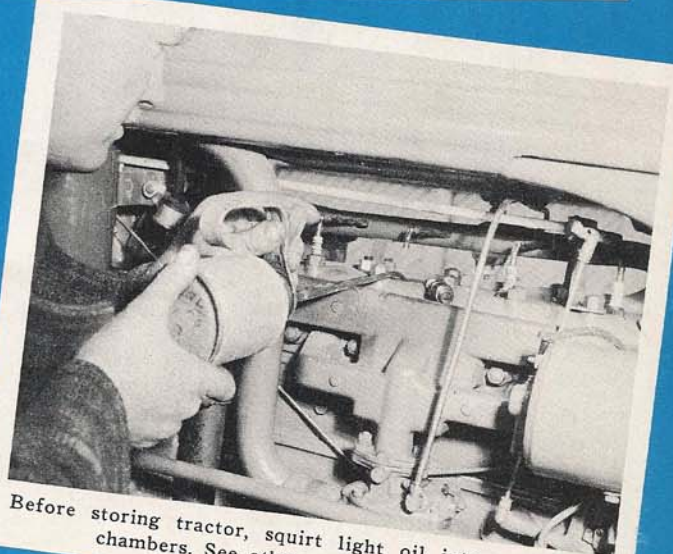

Before storing tractor, squirt light oil into combustion chambers. See other storage suggestions.

ing will always have on hand a reasonable supply of parts. Such a supply, for example, includes:

1. One "Trac-Pak" which contains four oil filter cartridges.
2. One fuel filter bowl.
3. One fuel strainer.
4. Four spark plugs.
5. One fan belt.
6. One oil filler cap assembly.
7. One link pin (for upper connection).
8. Two lynch pins (for lower connections).
9. Two lynch pin rings and two chain assemblies.
10. Extra sets of sharp plow shares.
11. Extra sweeps and shovels.
12. Extra can of transmission oil.

Ferguson Implements should be kept under cover, cleaned and oiled. Rust, not wear, is the greatest destroyer of implements. It is just about true that the more care you use to keep your implements from rusting the longer they will last and the better they will work.

Lubrication

An implement should always be lubricated before it is taken out to work. In addition, it should be lubricated several times a day, the frequency de-

pending on (1) severity of use and (2) dust conditions. Lubricate only where fittings are provided. At other working points, wipe clean but do not lubricate, as the lubricant would hold dirt, increasing wear.

★ ★ ★

A separate instruction book is supplied with the Ford Tractor Ferguson System and with each Ferguson Implement. Use these books in conjunction with this one for complete information about your equipment and greatest possible satisfaction.

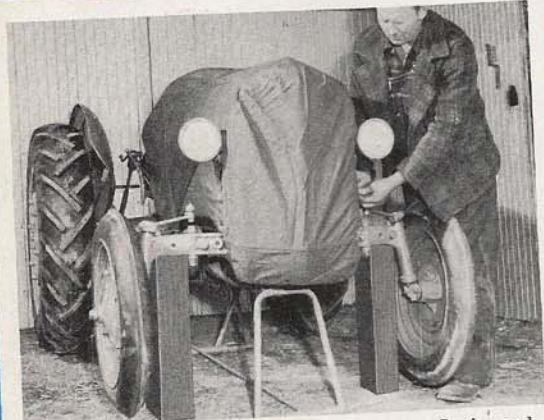

Prepared for storage—on Ferguson Jack and blocks, protected by Ferguson cover.

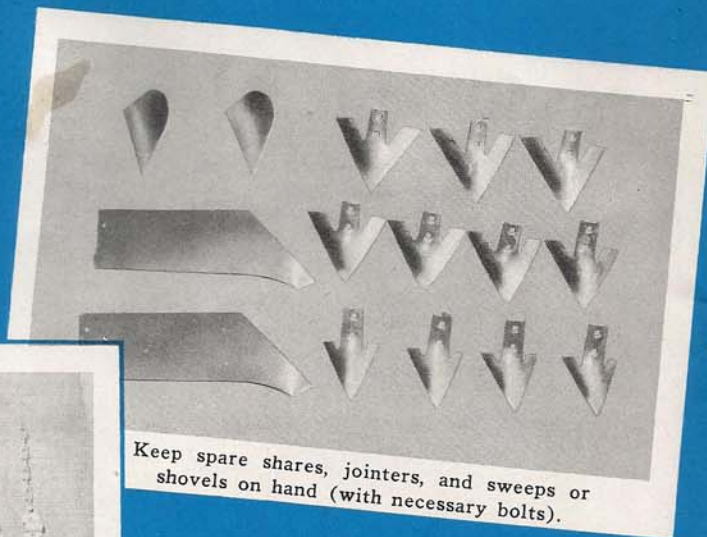

Keep spare shares, jointers, and sweeps or shovels on hand (with necessary bolts).



Recommended tractor parts to keep on hand.

TRACTOR, POWER TAKE-OFF, PULLEY AND W-W GRINDER BELT SPEEDS

Engine RPM	PTO Speed RPM	Tractor Pulley Speed RPM	TRACTOR PULLEY 9"		TRACTOR PULLEY 8.12" (8 $\frac{1}{8}$ ")	
			Belt Speed FPM	3 $\frac{1}{2}$ " Pulley Grinder Speed RPM	Belt Speed FPM	3 $\frac{1}{2}$ " Pulley Grinder Speed RPM
1000	364	679	1599	1744	1442	1575
1100	400	747	1759	1918	1586	1732
1200	436	815	1919	2090	1731	1889
1300	473	882	2079	2260	1879	2047
1400	509	950	2239	2440	2019	2204
1500	545	1018	2399	2670	2163	2362
1600	582	1086	2559	2780	2309	2519
1700	618	1154	2719	2960	2452	2677
1800	655	1222	2879	3140	2596	2834
1900	691	1290	3039	3300	2740	2996
2000	727	1358	3197	3490	2884	3150

PTO — Power Take-off

RPM — Revolutions Per Minute

FPM — Feet Per Minute

PTO Speed = Engine RPM x .36

Pulley Speed = Engine RPM x .68

Pulley Speed = PTO RPM x 1.86

Belt Speed = (9" Tractor Pulley) Engine RPM
x 1.6

Belt Speed = (8.12" Tractor Pulley) Engine
RPM x 1.44

Grinder Speed (Equipped with 3 $\frac{1}{2}$ " Grinder
Pulley and 9" Tractor Pulley) = Engine RPM
x 1.74

Grinder Speed (Equipped with 3 $\frac{1}{2}$ " Grinder
Pulley and 8.12" Tractor Pulley) = Engine
RPM x 1.57

MAINTENANCE SCHEDULE

Fifteen Minutes a Day Will Keep Trouble Away

Make the following inspections a part of your day — it will pay you dividends in long, trouble-free tractor operation.

Keep the tractor clean — remove dirt before lubricating grease fittings and inspecting filler caps. Distributor cap, spark plugs and all electrical connections *must* be clean to operate efficiently.

Time	Lub. Chart	Maintenance Operation	Page Number
Each Morning	■	AIR CLEANER — (Capacity 1 pint.) Clean and refill lower bowl with same oil used in engine. Clean top screen, wash in gasoline if oily.	45
	●	LUBRICATE — Grease fittings with grease gun.	44
	■	CRANKCASE — Check oil dip stick — keep oil within working range as shown on dip stick. Change oil when oil is dark enough to prevent easy reading of letters on dip stick. Capacity 6 quarts. Allow additional oil for absorption by new filter cartridge.	41
		OIL FILLER CAP — Inspect and clean — wash in gasoline when dirty.	44
		FUEL OR SEDIMENT BULB — Check for water and sediment. Clean bulb and strainer if necessary	47
	□	DIFFERENTIAL AND TRANSMISSION — (Capacity 5 gallons.) Examine dip stick and keep oil to high level.	43
		COOLING SYSTEM — (Capacity 12 quarts.) Keep filled with clean soft water or anti-freeze. (Tractors not equipped with pressure cap take 14 quarts.)	49
	BATTERY — Remove dirt or dust collection. Check water level in battery. Keep generator charging rate to lowest point that will keep battery fully charged — an excessive charging rate boils away the solution.	52	
Noon		EXAMINE AIR CLEANER when working in dusty conditions. Clean when necessary.	45
Every 20 to 60 Working Hours	□	BELT PULLEY — Examine and refill if necessary every 60 hours — same oil as used for hydraulic mechanism.	43
		ALL BOLTS AND NUTS — Check all bolts and nuts for tightness every 20 hours for first week when tractor is new and every 60 hours thereafter.	55
Every 100 to 600 Working Hours	□	TRANSMISSION, HYDRAULIC MECHANISM AND DIFFERENTIAL — Change oil in a new tractor after first 200 hours — thereafter every 600 hours.	43
	■	ENGINE OIL — Change not less than every 200 hours — or when oil shows dark on stick.	41
		CHANGE OIL FILTER — When engine oil is changed, or as soon as oil shows dark on dip stick.	42
	○	FRONT WHEEL HUB BEARINGS — Not equipped with grease fittings — pack with short fiber grease each season and adjust wheel bearings correctly.	41
	■	REAR GENERATOR BEARING — Oil every 300 hours.	41
		AIR CLEANER — Remove complete assembly — thoroughly clean with gasoline. In extreme dust conditions, clean every 100 hours.	45
	FLUSH RADIATOR — Every 100 to 200 hours, or at least twice a year.	50	

LUBRICATION CHART

FORD TRACTOR FERGUSON SYSTEM

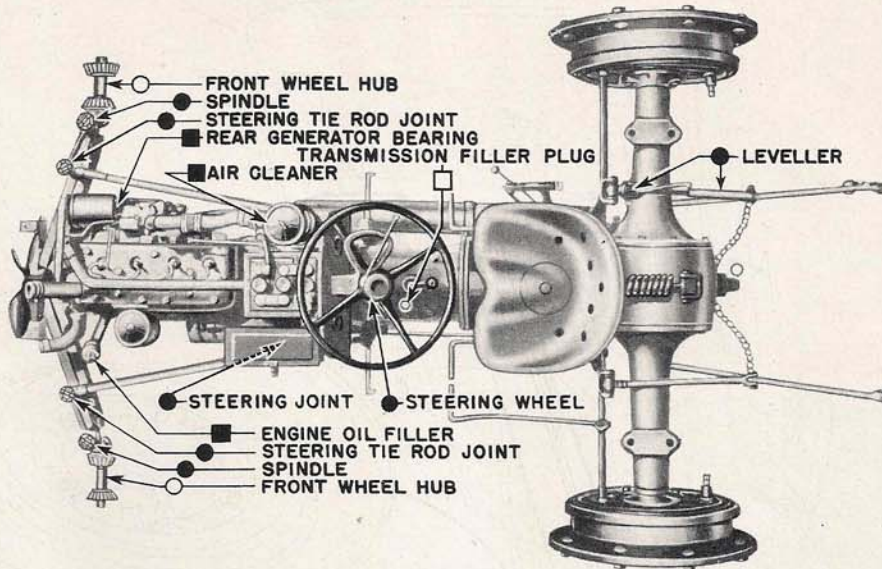

LUBRICATION

- ENGINE OIL
 - Use S.A.E. 30 for temperatures above 90°
 - Use S.A.E. 20 for temperatures between 32° and 90°
 - Use S.A.E. 20W for temperatures between 10° and 32°
 - Use S.A.E. 10W for temperatures between -10° and 10°
- TRANSMISSION, HYDRAULIC MECHANISM AND DIFFERENTIAL OIL
 - For temperatures above freezing, use straight mineral oil S.A.E. 90
 - For temperatures below freezing, use straight mineral oil S.A.E. 80
- PRESSURE GUN OR CHASSIS LUBRICANT
- GREASE
 - Use high-grade short fiber grease

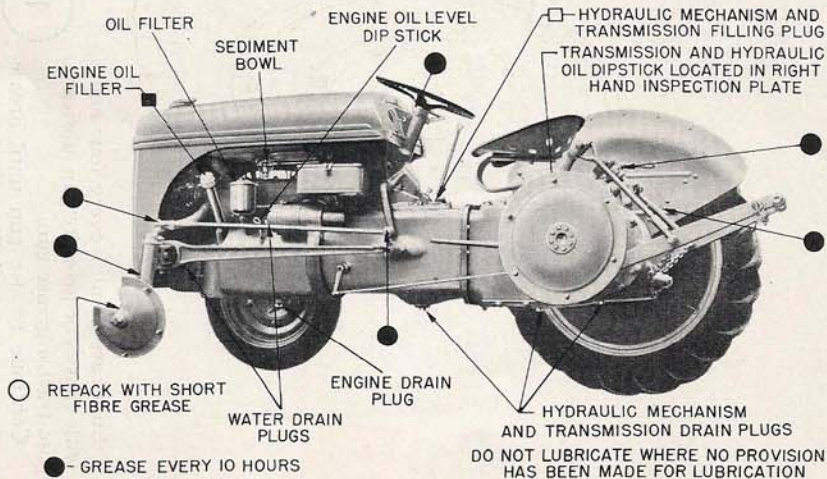

LUBRICATION CHART

FERGUSON DISC TERRACER A-FO-20

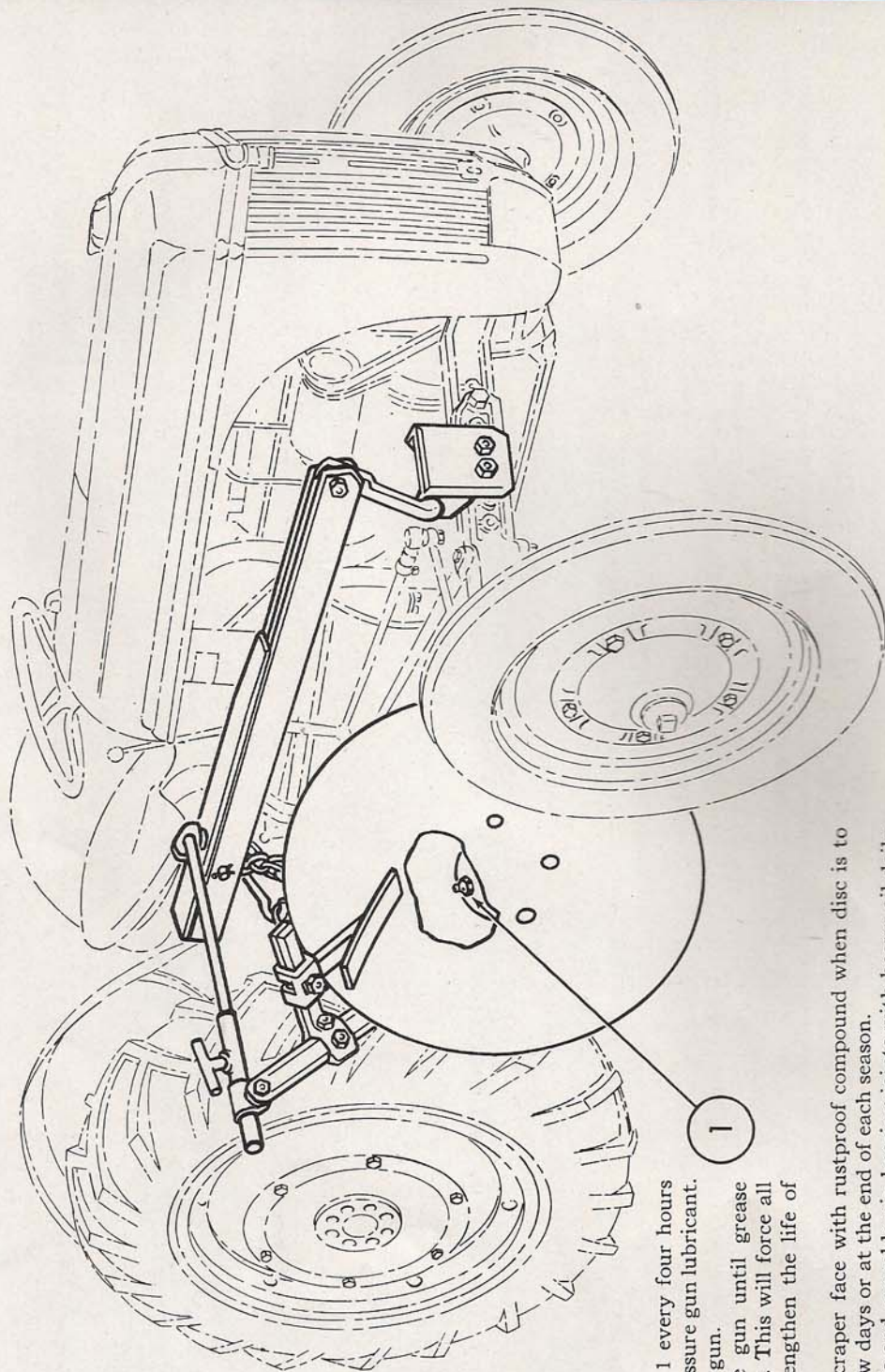

Lubricate point 1 every four hours with chassis or pressure gun lubricant. Use tractor grease gun.

Continue to use gun until grease appears at bearing. This will force all the grit out and lengthen the life of the bearings.

Coat disc and scraper face with rustproof compound when disc is to remain idle for a few days or at the end of each season.

Lubricate threads and movable pin bearing joints with heavy oil daily except in sandy or abrasive soil. Under these conditions do not lubricate these points.

LUBRICATION CHART

FERGUSON - 2 BOTTOM MOLDBOARD PLOWS

10-AO, 12-AO, 14-AO

Lubricate the following points

- | | | |
|------------|---------------|---------------------------------------------|
| 1, 3 and 4 | Every 4 hours | } Lubricant — Chassis or pres-
sure gun. |
| 2 | Daily | |
- Use tractor grease gun.

Coat earth polished parts with rustproof com-
pound when plow is to be idle for a few days or
when storing.

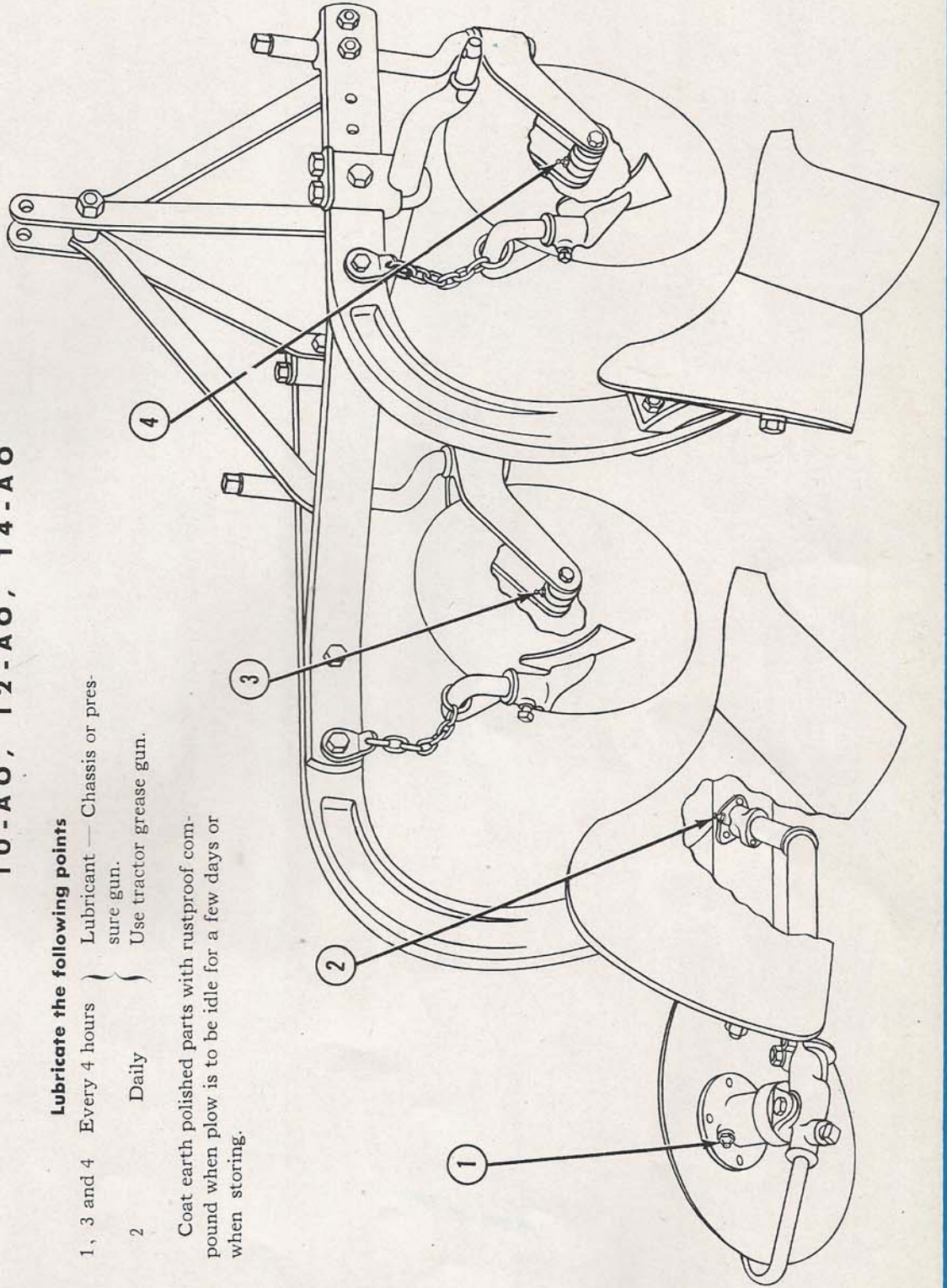

LUBRICATION CHART

DISC PLOW

AP-2-D

Lubricate the following points:

- | | | |
|------------|---------------|----------------------------------------|
| 1, 2 and 3 | Every 4 hours | } Lubricant — Chassis or pressure gun. |
| 4 | Daily | |

Coat discs with rustproof compound when plow is to remain idle for a few days or storing at the end of season.

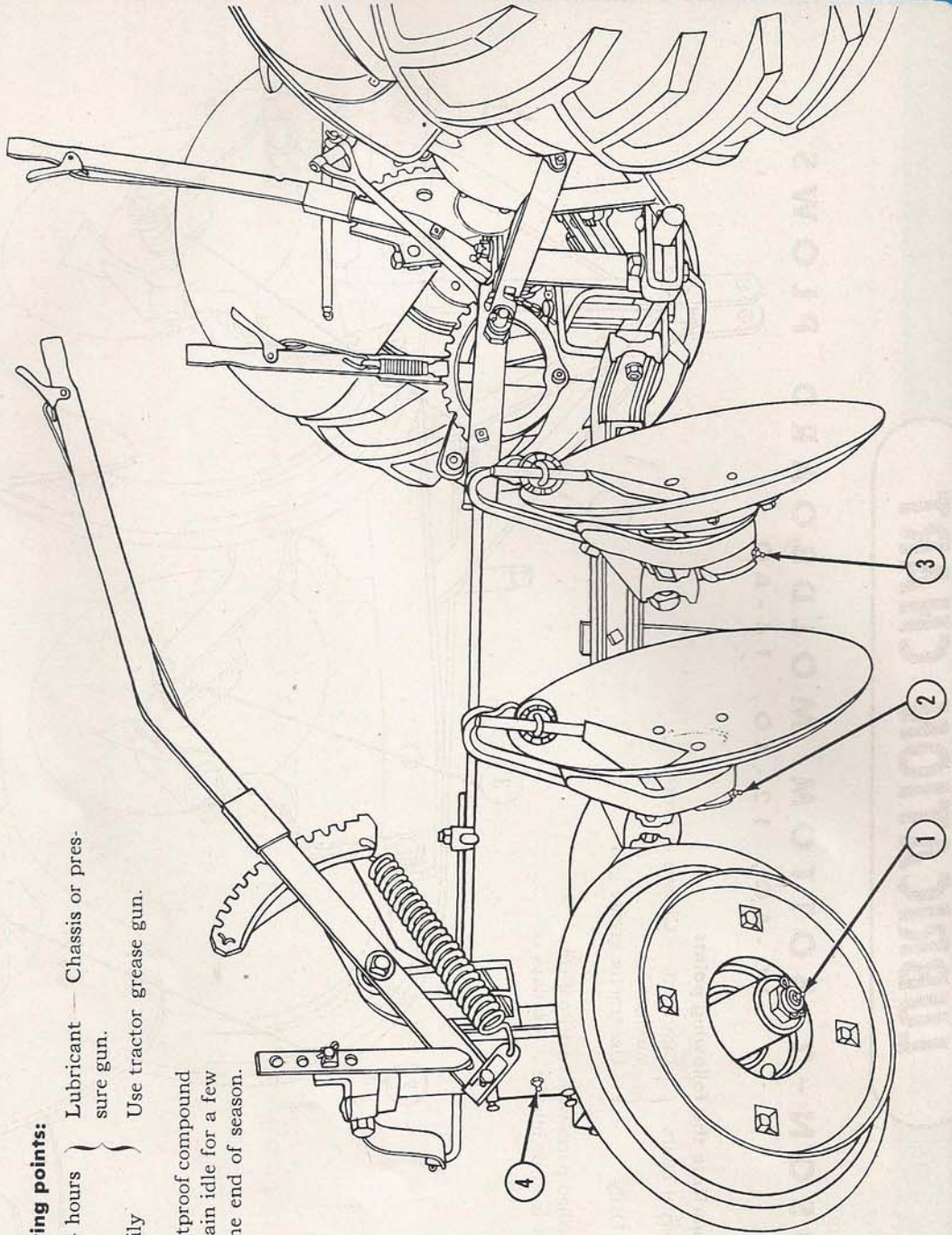

LUBRICATION CHART

FERGUSON TANDEM DISC HARROW

A-BO 21

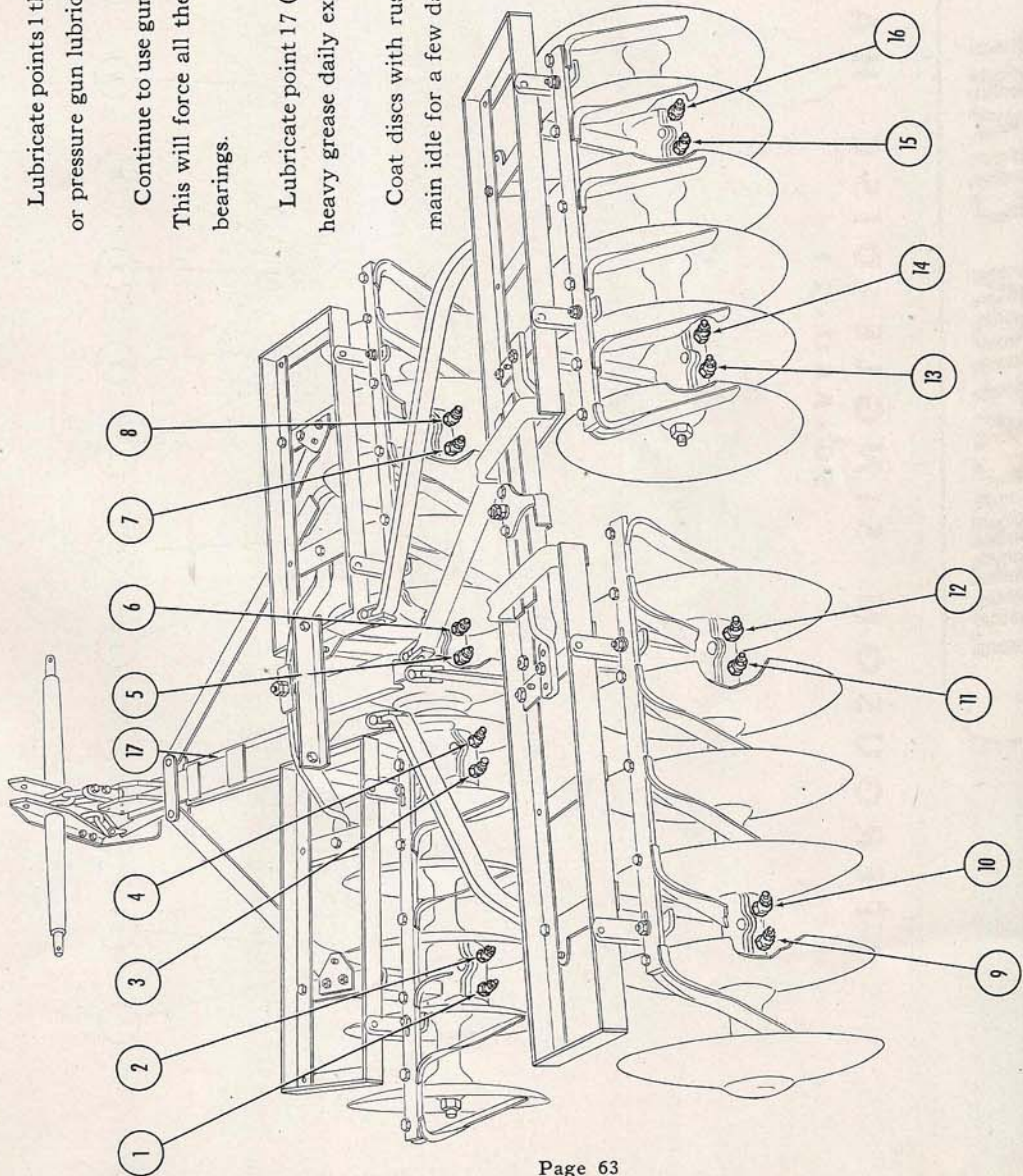

Lubricate points 1 through 16 every four hours with chassis or pressure gun lubricant. Use tractor grease gun.

Continue to use gun until grease appears at bearing ends. This will force all the grit out and lengthen the life of the bearings.

Lubricate point 17 (disc hitch angling slide members) with heavy grease daily except in sandy or abrasive soils.

Coat discs with rustproof compound when disc is to remain idle for a few days or at the end of each season.

LUBRICATION CHART

FERGUSON SINGLE DISC HARROW

50-ABO-21

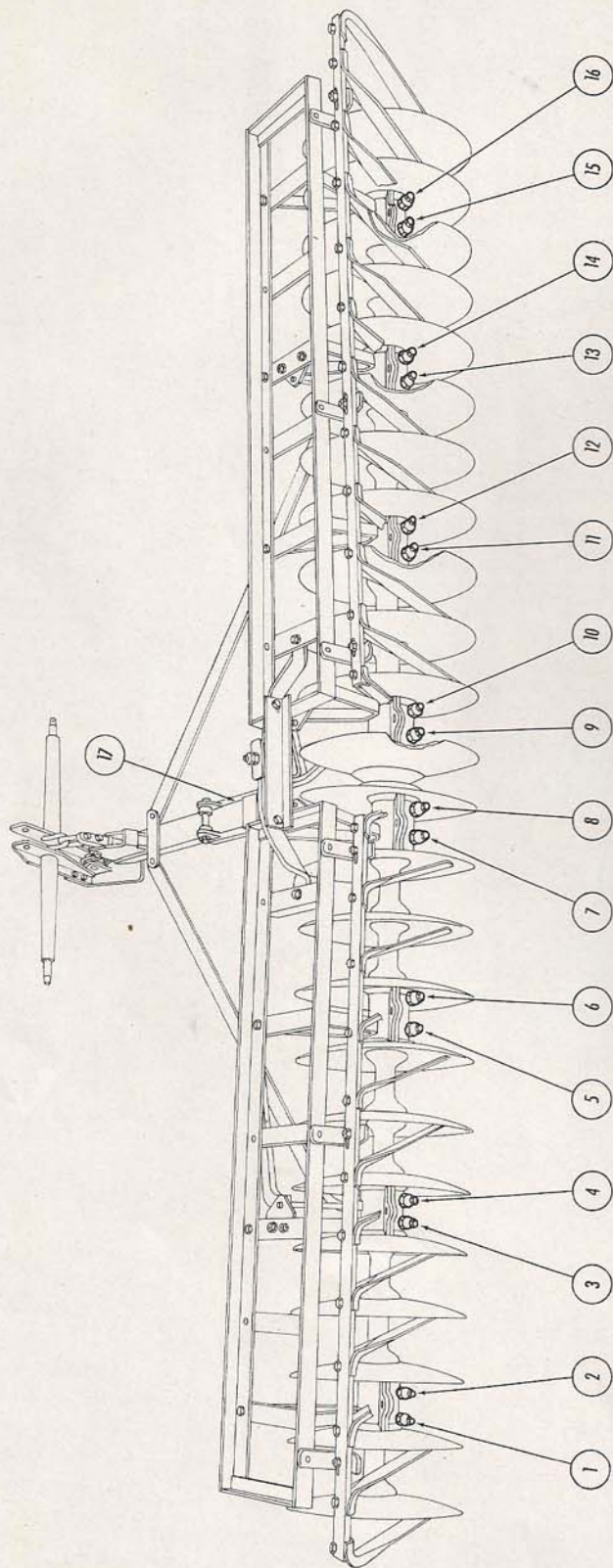

Lubricate points 1 through 16 every four hours with chassis or pressure gun lubricant. Use tractor grease gun.

Continue to use gun until grease appears at bearing ends. This will force all the grit out and lengthen the life of the bearings.

Lubricate point 17 (disc hitch angling slide members) with heavy grease daily except in sandy or abrasive soils.

Coat disc with rustproof compound when disc is to remain idle for a few days or at the end of each season.

LUBRICATION CHART

HEAVY-DUTY DISC HARROWS RD-823 AND RD-820

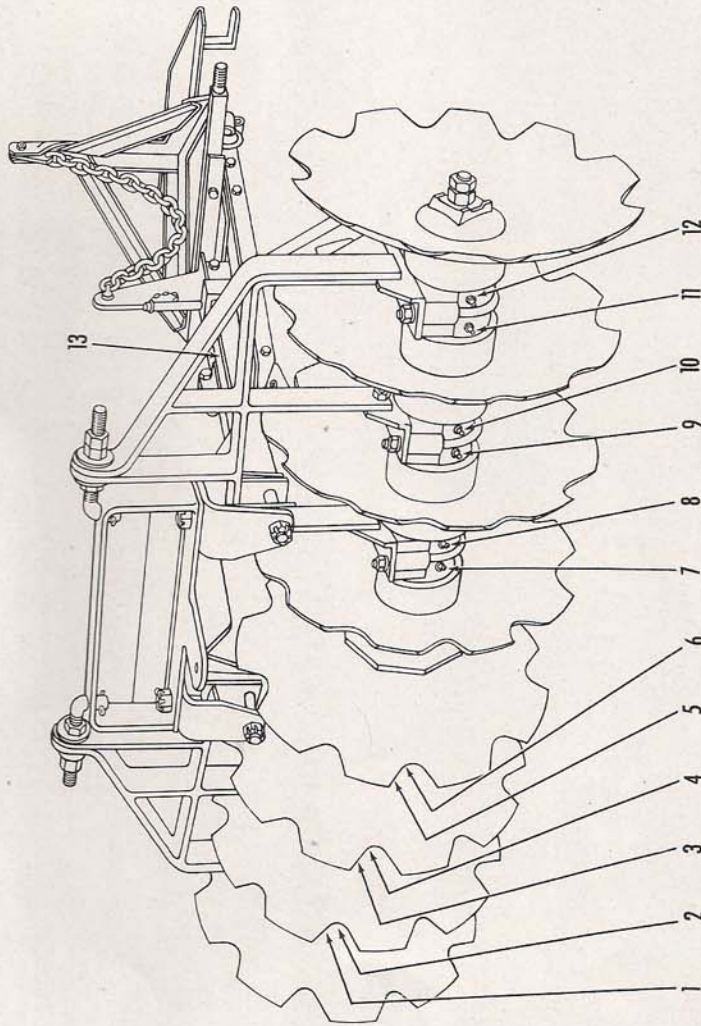

Lubricate points 1 through 8 (RD-820) or 12 (RD-823) every four hours with chassis or pressure gun lubricant. Use tractor grease gun.

Continue to use gun until grease appears at bearing ends. This will force all the grit out and lengthen the life of the bearings.

Lubricate point 13 (disc hitch angling slide members) with heavy grease daily except in sandy or abrasive soils.

Coat discs with rustproof compound when disc is to remain idle for a few days or at the end of each season.

The RD-823 is a drag-type, heavy-duty disc harrow and has 12 lubrication fittings.

The RD-820 is a lift-type, heavy-duty disc harrow and has 8 lubrication fittings.

LUBRICATION CHART

FERGUSON AGRICULTURAL MOWER A - E O - 20

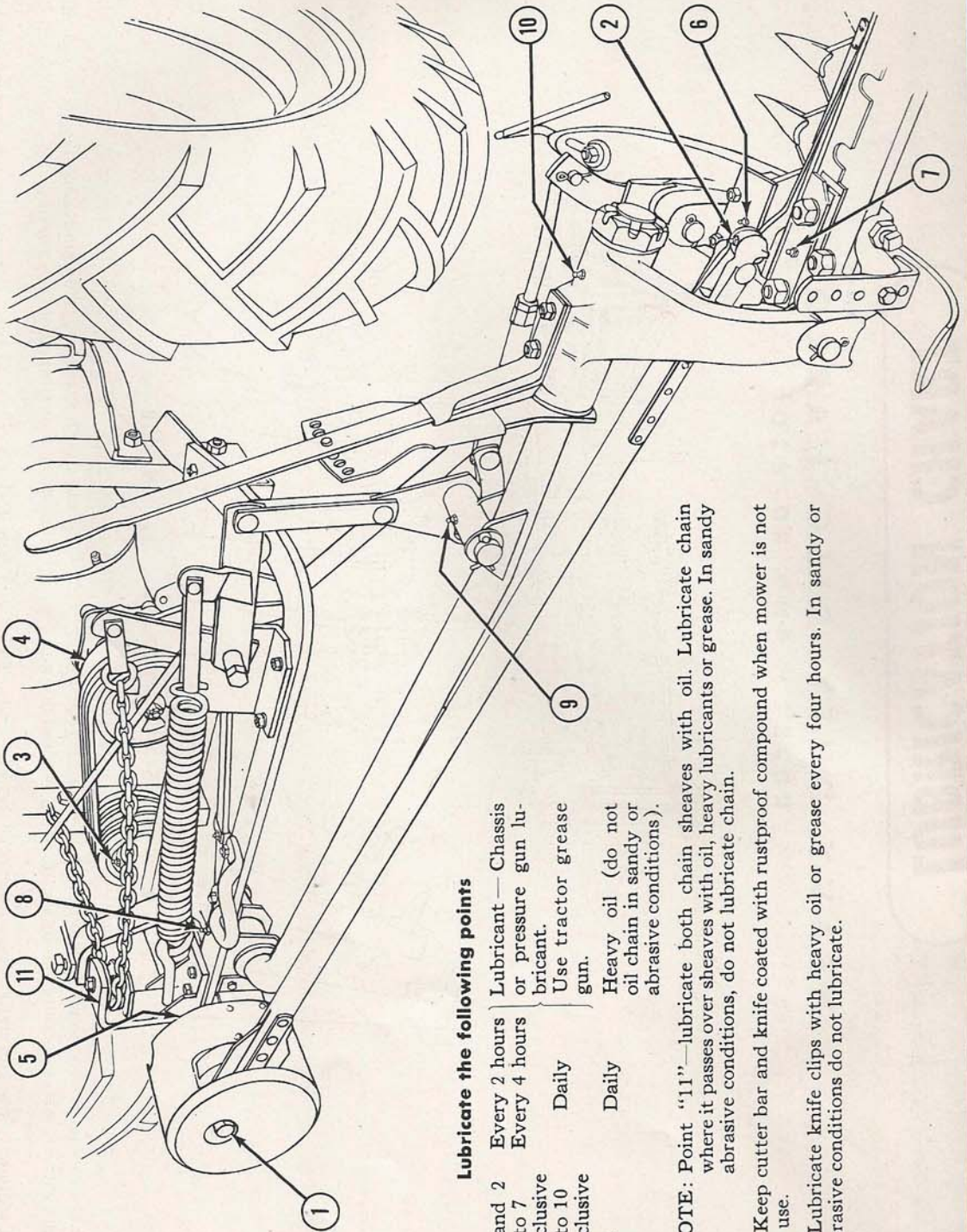

Lubricate the following points

1 and 2	Every 2 hours	Lubricant — Chassis or pressure gun lubricant.
3 to 7 inclusive	Every 4 hours	
8 to 10 inclusive	Daily	Use tractor grease gun.
11	Daily	Heavy oil (do not oil chain in sandy or abrasive conditions).

NOTE: Point "11"—lubricate both chain sheaves with oil. Lubricate chain where it passes over sheaves with oil, heavy lubricants or grease. In sandy abrasive conditions, do not lubricate chain.

Keep cutter bar and knife coated with rustproof compound when mower is not in use.

Lubricate knife clips with heavy oil or grease every four hours. In sandy or abrasive conditions do not lubricate.

LUBRICATION CHART

HEAVY-DUTY (PEO) MOWER

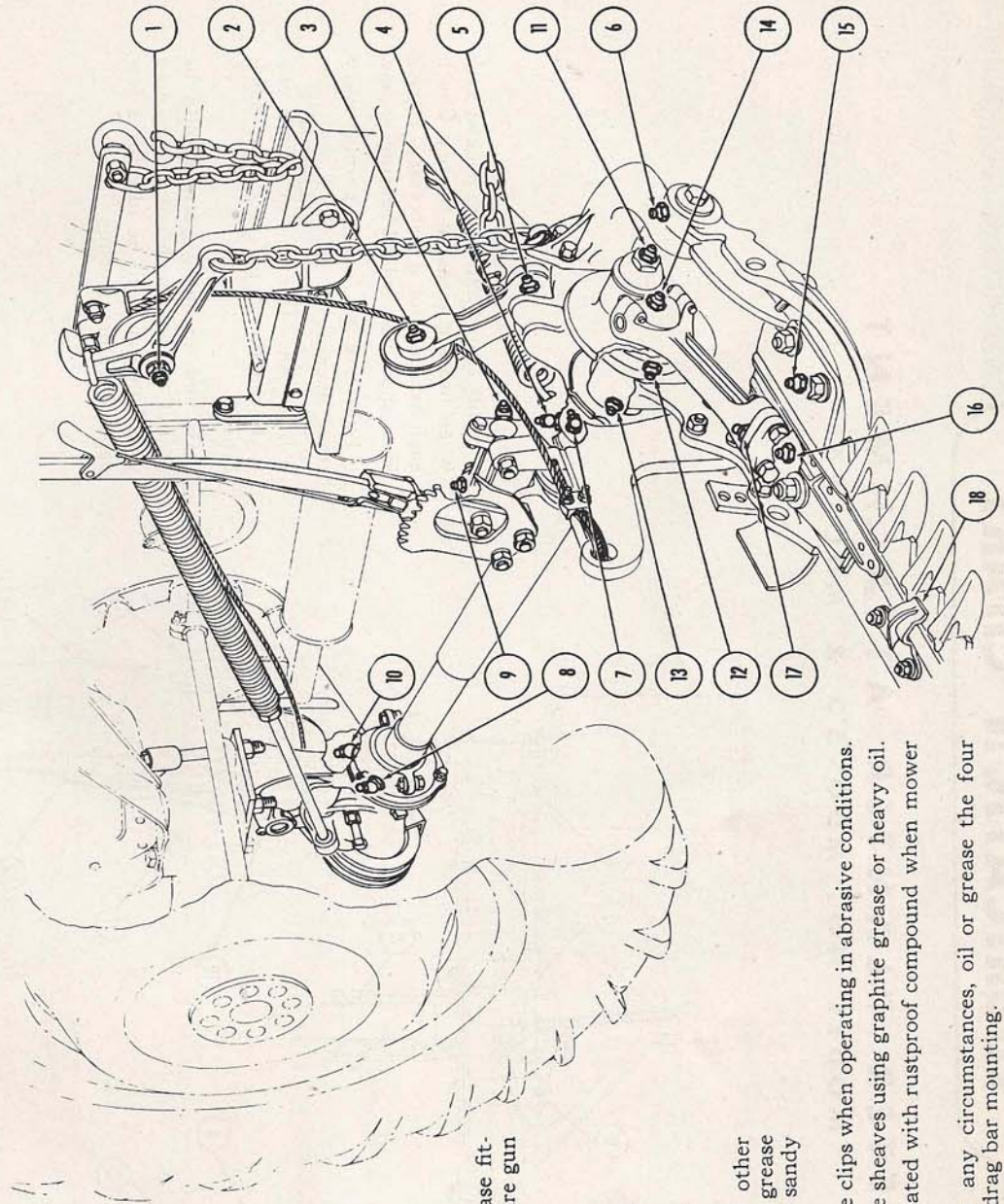

1. Lubricate the following grease fittings using chassis or pressure gun lubricant.

Use tractor grease gun.

- a. Fittings, 1 to 10—daily
- b. Fittings, 11 to 13—every 4 hours.
- c. Fittings, 14 to 17—every 2 hours.

2. Lubricate point 18 and all other knife clips with heavy oil or grease four times daily except in sandy abrasive conditions.

CAUTION: Do *Not* lubricate clips when operating in abrasive conditions.

3. Lubricate lifting cables at the sheaves using graphite grease or heavy oil.

4. Keep cutter bar and knife coated with rustproof compound when mower is not in use.

CAUTION: Do *Not* under any circumstances, oil or grease the four rubber bushings used in the drag bar mounting.

LUBRICATION CHART

LISTER PLANTER ATTACHMENT

MODEL NO. MDO-50 & MDO-55

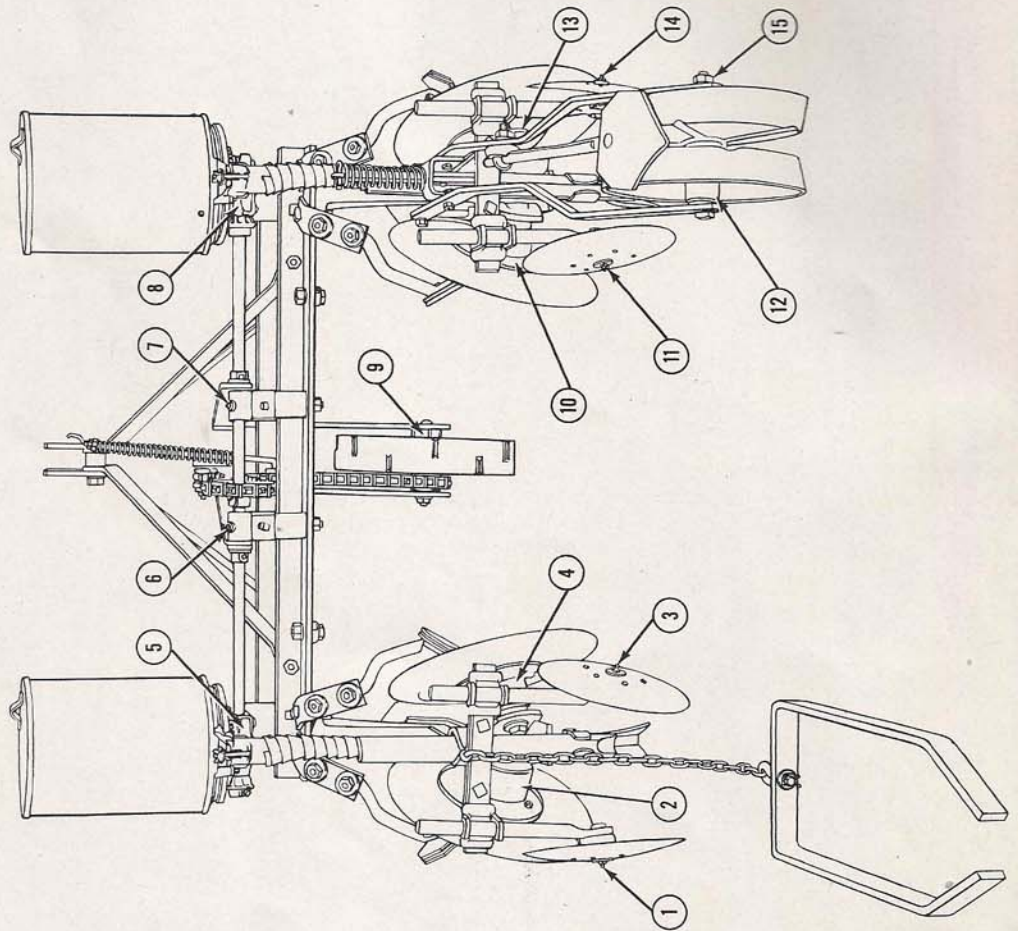

Points 2, 4, 10 and 13 are packed with wheel bearing grease at factory. Check each season, and if necessary, repack with short fiber wheel bearing grease.

Lubricate all other points every three hours.

Lubricant—Use tractor grease gun with chassis or pressure gun lubricant.

Ground engaging parts should be coated with rustproof compound when planter is to be idle for a few days or before storing.

LUBRICATION CHART

LISTER CULTIVATOR

L-KO-A-20

Points 1, 2, 4 and 5 are packed with wheel bearing grease at the factory. Check each season, and if necessary, repack with short fiber wheel bearing grease.

Lubricate point 3 every three hours.

Lubricant—Use tractor grease gun with chassis or pressure gun lubricant.

Keep all ground engaging parts covered with a rustproof compound when cultivator is to be idle for a few days or before storing.

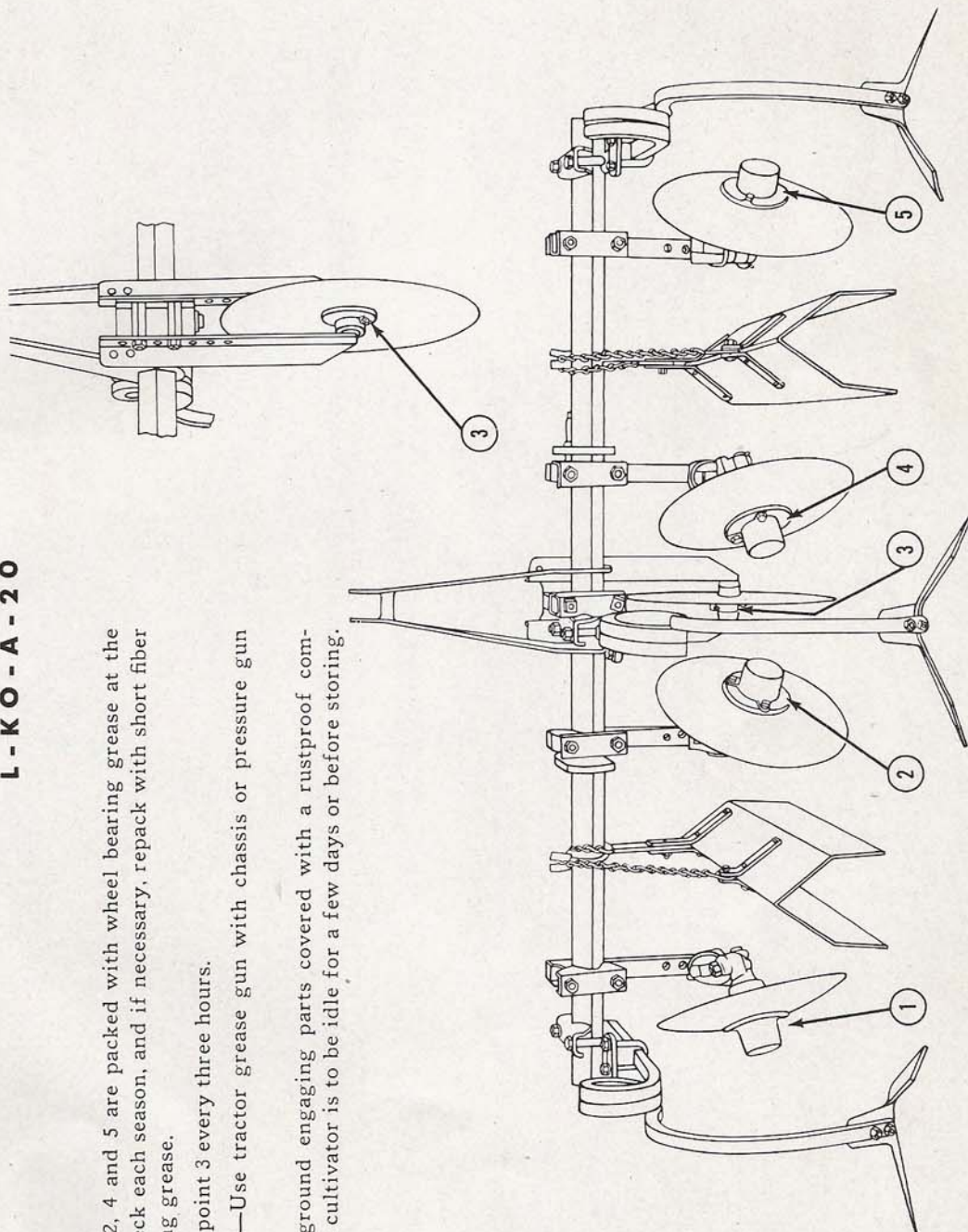

LUBRICATION CHART

WB-1-P CORN PICKER FRONT VIEW

Lubricate fittings 1 through 65 every four hours using a good grade of chassis or pressure gun lubricant. Use tractor grease gun.

Steel chains should be lubricated with motor oil every 20 hours.

Roller chains should be removed, washed in solvent and soaked in hot transmission lubricant seasonally or oftener, if needed.

A cheaper but less thorough method is brushing salvaged oil on the chain several times a week. Use only top oil which has had the sludge and sediment settled to the bottom of the container.

Slip clutch fingers should be oiled with motor oil every 20 hours.

Open gears should be lubricated every 20 hours with a good grade of open gear lubricant.

A definite procedure of lubrication should be established and followed to obtain a quick, yet thorough, lubrication of the corn picker. We would suggest starting at point one on lubrication chart and follow the numbers consecutively.

When harvesting corn on sandy soil, lubricate Nos. 55, 56, 57, 64, 65 every 2 hours.

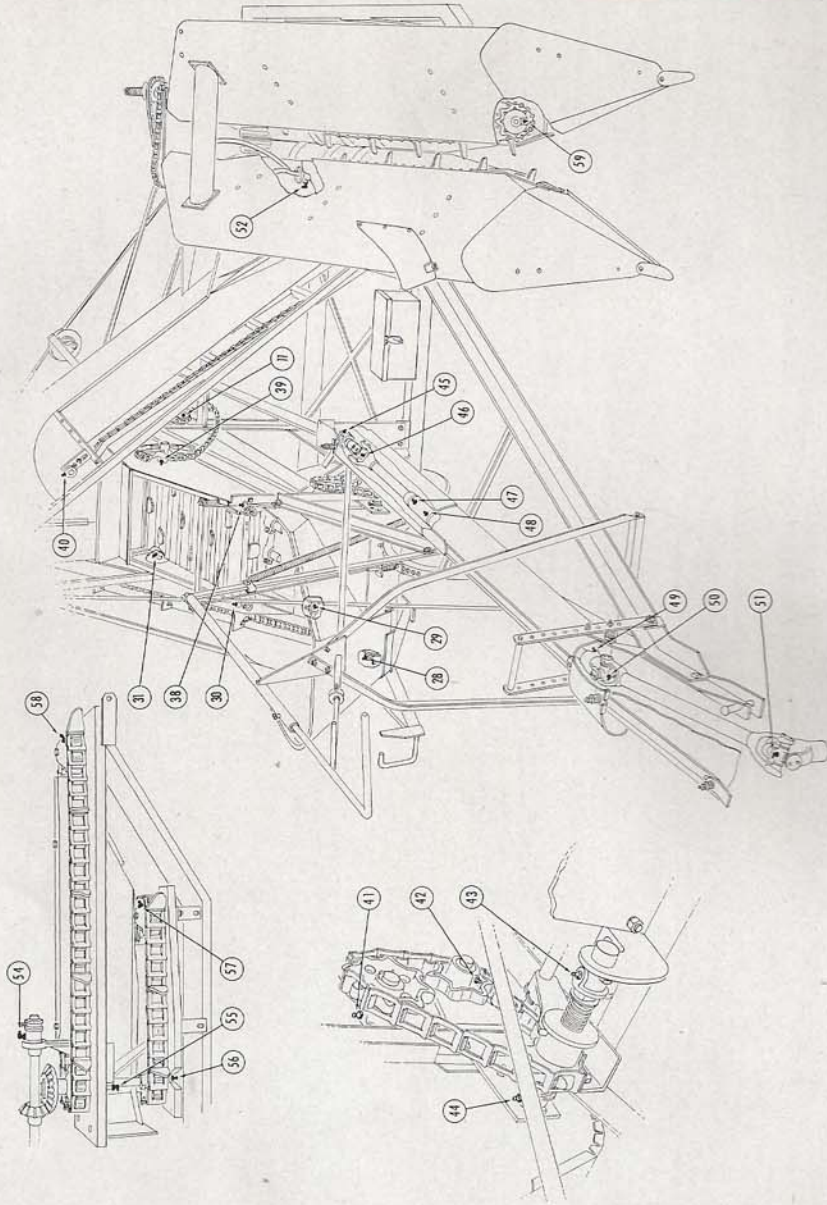

LUBRICATION CHART

WB-1-P CORN PICKER REAR VIEW

Lubricate fittings 1 through 65 every four hours using a good grade of chassis or pressure gun lubricant. Use tractor grease gun.

Steel chains should be lubricated with motor oil every 20 hours.

Roller chains should be removed, washed in solvent and soaked in hot transmission lubricant seasonally or oftener, if needed.

A cheaper but less thorough method is brushing salvaged oil on the chain several times a week. Use only top oil which has had the sludge and sediment settled to the bottom of the container.

Slip clutch fingers should be oiled with motor oil every 20 hours.

Open gears should be lubricated every 20 hours with a good grade of open gear lubricant.

A definite procedure of lubrication should be established and followed to obtain a quick, yet thorough, lubrication of the corn picker. We would suggest starting at point one on lubrication chart and follow the numbers consecutively.

When harvesting corn on sandy soil, lubricate Nos. 55, 56, 57, 64, 65 every 2 hours.

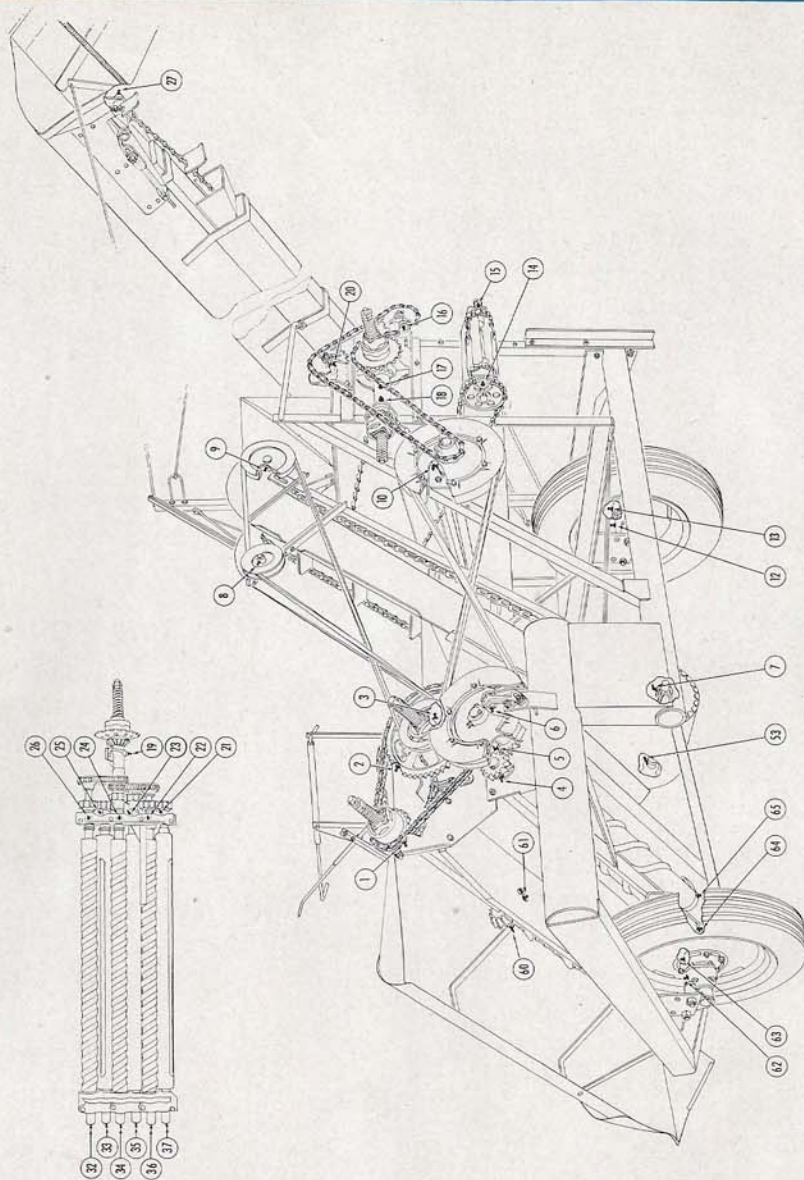

INDEX

Air Cleaner			
Care	45		
Extension Stack	47		
Ammeter	51		
Anti-freeze	49		
Attaching Implements	15		
Brakes			
Adjustment	14		
Use of	14		
Belt Speeds	57		
Carburetor			
Adjustment	48		
Care of	48		
Clutch			
Adjustment	14		
Use of	10, 14		
Cooling System			
Capacity	50		
Draining	50		
Thermostat	50		
Radiator	51		
Control Spring Adjustment	15		
Corn Picker, Lubrication	70, 71		
Coulters, Adjustment	25		
Cultivators	34		
Depth Control, Implement	7		
Disc Harrows			
Adjustment	31		
Attaching	30		
Description	29		
Lubrication	63-65		
Disc Plow, Lubrication	62		
Disc Terracer, Lubrication	60		
Drawbar, Use and Adjustment	17		
Electrical System	51		
Fenders, Cultivator	36		
Ferguson System, The			
Automatic Implement Control	7		
Finger Tip Control	7		
Five Exclusive Advantages	7		
Implement Attachment	6, 15		
Use of Nature's Laws	5		
Fin, Cultivator	35		
Fuel, Excessive Consumption	13		
Fuel System			
Care of	47		
Filter	47		
Reserve Valve	47		
Gauge, Oil Pressure	11		
Gears, Shifting	12		
Generator	51		
Grinder, W-W Speeds	57		
Hydraulic System			
Operation	6, 7		
Care	14, 53		
Jointers			
Adjustment	26		
Purpose of	26		
Linkage, Care of	18, 53		
Lister Cultivator, Lubrication	69		
Lister Planter, Lubrication	68		
Lubrication, Importance of	41		
Lubrication Charts	59-71		
Maintenance Schedule, Tractor	58		
Mower, Agricultural, Lubrication	66		
Mower, Heavy-Duty, Lubrication	67		
Obstructions, Protection of			
Implements from	8		
Oil			
Engine	41, 59		
Grades to Use	59		
Transmission	43, 59		
When to Change	58		
Parts to Keep on Hand	55		
Penetration, Implement	7		
Plow			
Adjustment	25-29		
Description	20-24		
Lubrication	61		
Plowing	22-25		
Power Take-off	16		
Power Take-off Speeds	57		
Pulley Sizes and Speeds	57		
Quadrant, Finger Tip Control	15		
Safety Rules	19		
Sediment Bulb	47		
Shares, Plow	29		
Spark Plugs	52		
Steering Guide, Cultivator	35		
Tiller	37		
Tires			
Inflation	53		
Care of	53		
Top Link	6		
Tractor			
Care of	40		
Lubrication Chart	59		
Removing from Storage	55		
Starting	10		
Storing	54		
Traction, Automatically Regulated	8		
Wheel Tread Widths	18		

RECORD OF TRACTOR WORKING HOURS



How To Use It

The Record of Tractor Working Hours (see next two pages) can be kept in this book or posted inside your tractor shed, as desired.

Spaces are provided for entering the number of hours you use your tractor each day. The complete record will cover an entire year.

It is better to keep the record on a cumulative basis. For example: If, the first day, you operate your tractor 10 hours, mark 10 in the space for that day. If you operate it 8 hours the following day, add this to the previous 10 hours and enter the sum 18—and so on.

By keeping such a record, you will know just when the tractor is due for each kind of care listed at the left of the record blank.

The record is also valuable for figuring your tractor time costs by job or season, or on custom work.

Installation of a time-recorder on the tractor will enable you to keep an accurate record of the number of hours your tractor is operated. This is especially useful when doing custom work or using hired operators.

TRACTOR CARE

WHAT to do and WHEN to do it

EVERY 10 HOURS

Clean air cleaner screen and put clean oil in bowl if oil is dirty—Inspect air inlet screen, and clean if necessary—Clean and saturate oil filler cap with motor oil—Check dip stick on engine and add oil, if necessary—Check radiator and add water, if necessary—Lubricate steering column with two shots from grease gun—Use grease gun on front wheel spindles—On ball and socket joints at each end of steering drag links—On leveling crank gear box and on leveling crank threads.

EVERY 30 HOURS

Check battery and add water, if necessary, until level with lead washer in filler neck.

EVERY 60 HOURS

Check transmission dip stick and add oil, if necessary. Check oil in belt pulley and refill, if necessary. Drain carburetor and fuel line. Check sediment bowl in gas line and clean, if necessary. Check tire inflation. Front, 26 pounds; rear, 12 pounds.

EVERY 200 HOURS

Drain engine crankcase and refill with new oil. Put new cartridge into oil filter at each oil change, or as soon as oil shows dark on dip stick. Check and gap spark plugs to .025" to .028" clearance. (New plugs, 500 hrs.)

EVERY 300 HOURS

Oil rear bearing on generator with few drops of engine oil.

EVERY 600 HOURS

Drain transmission and refill with new oil.

DATE	JAN	FEB	M
1			
2			
3			
4			
5			
6			
7			
8			
9			
10			
11			
12			
13			
14			
15			
16			
17			
18			
19			
20			
21			
22			
23			
24			
25			
26			
27			
28			
29			
30			
31			

TRACTOR WORKING HOURS

MAR	APR	MAY	JUNE	JULY	AUG	SEPT	OCT	NOV	DEC	DATE
										1
										2
										3
										4
										5
										6
										7
										8
										9
										10
										11
										12
										13
										14
										15
										16
										17
										18
										19
										20
										21
										22
										23
										24
										25
										26
										27
										28
										29
										30
										31

CUT AND POST ON WALL OF TRACTOR SHED

www.ntractorclub.com

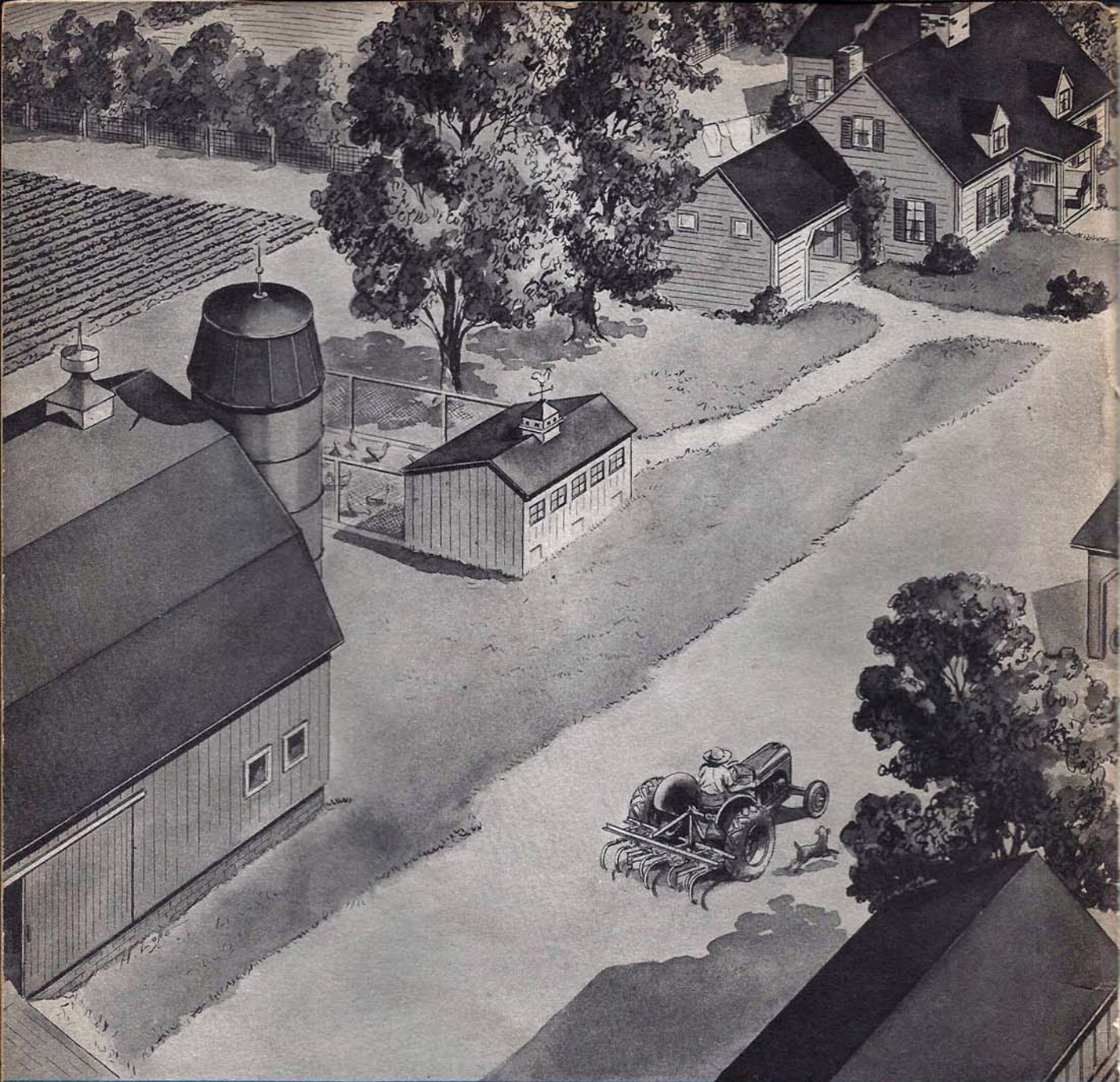

HARRY FERGUSON • INC.

DETROIT • MICHIGAN